

TRIUMF Science Week July 31 – Aug. 4, 2023

ISAC Beam Development Updates

Carla Babcock

for the Targets and Ion Sources Department and
Beam Development Strategy Group

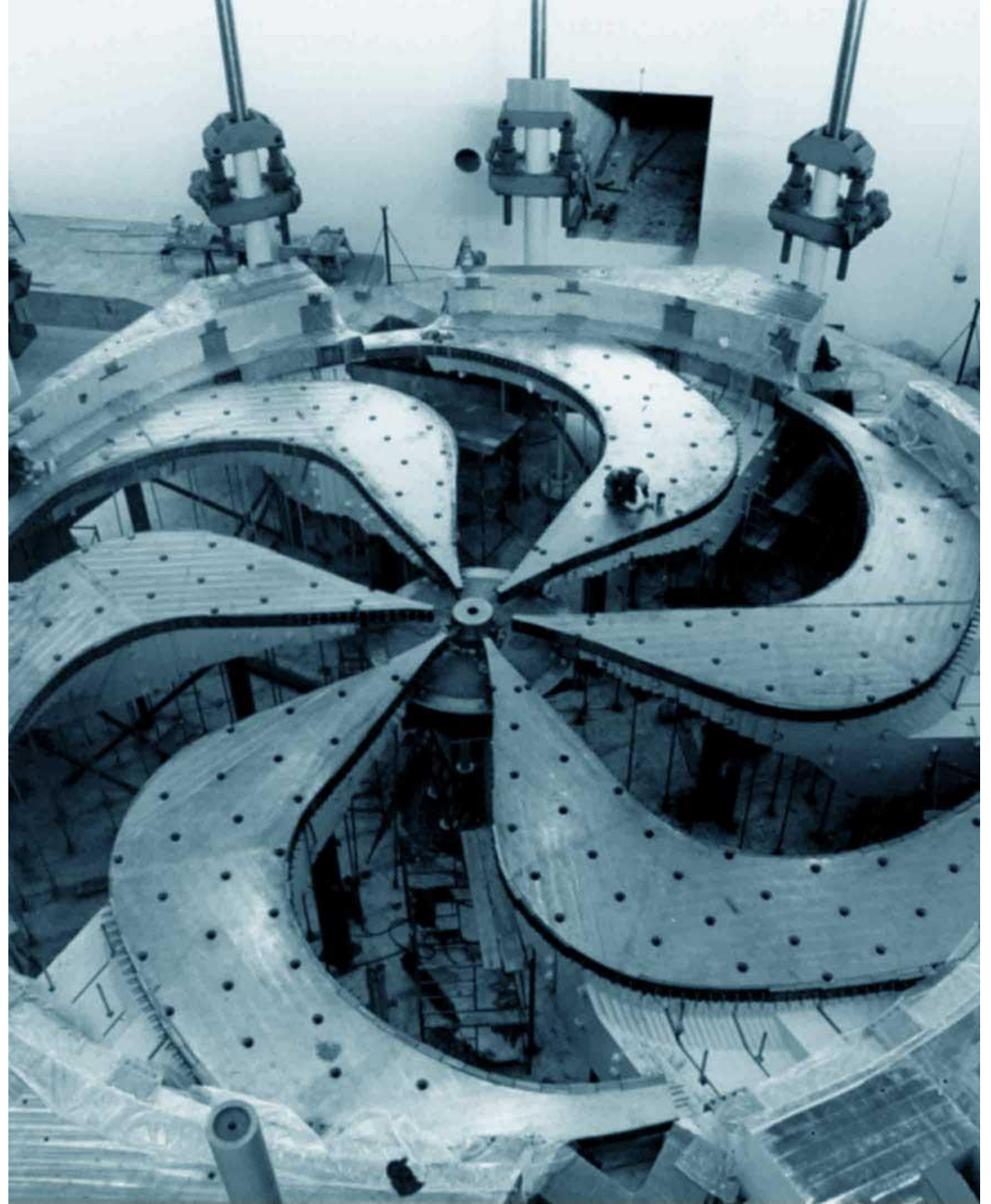

2022 Scheduled Beam Developments

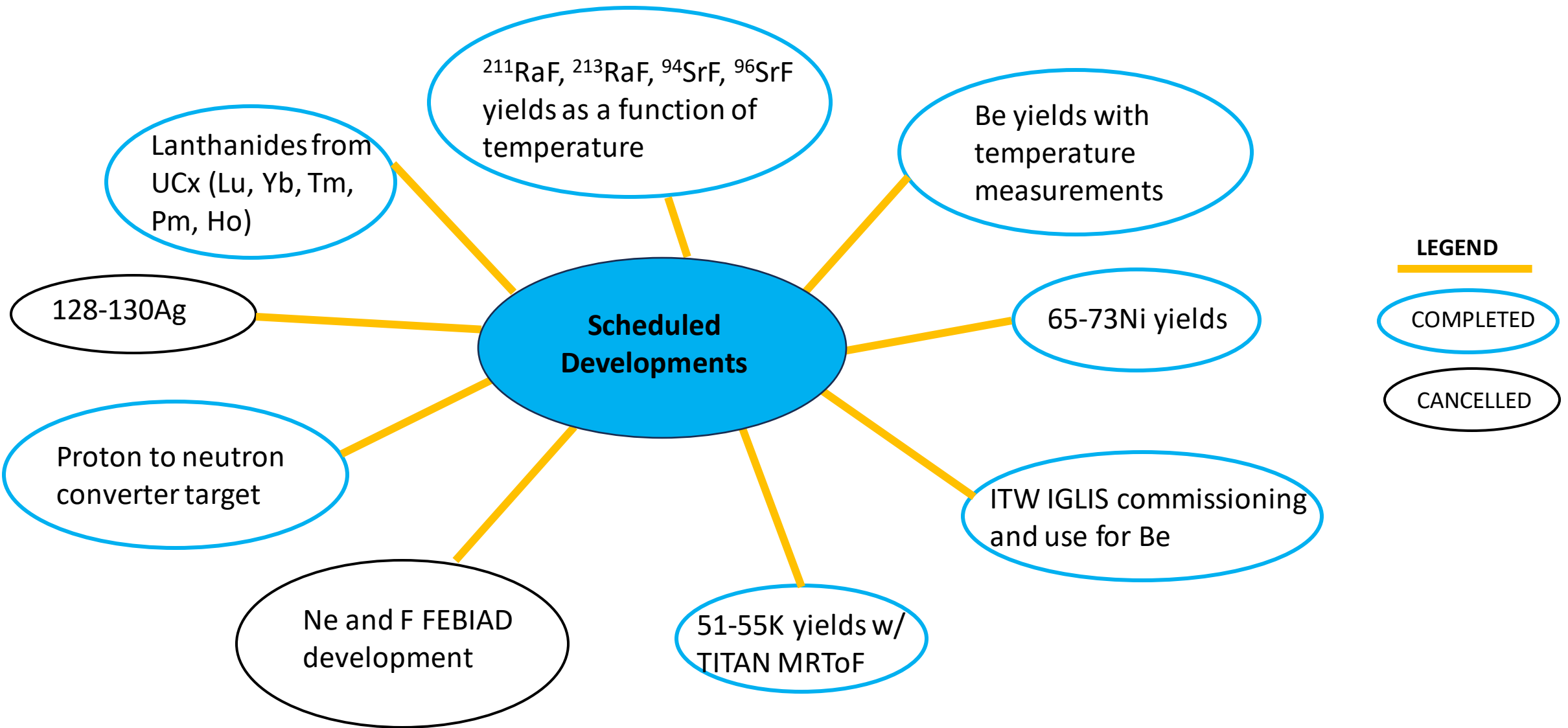

2023 Development Target

- **Ran two development targets for 10 days each in June:**
- Low power TiC FEBIAD
- High power TiC FEBIAD

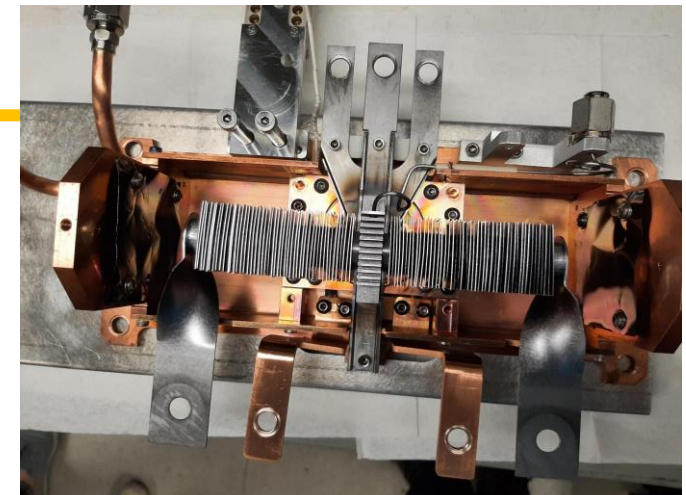
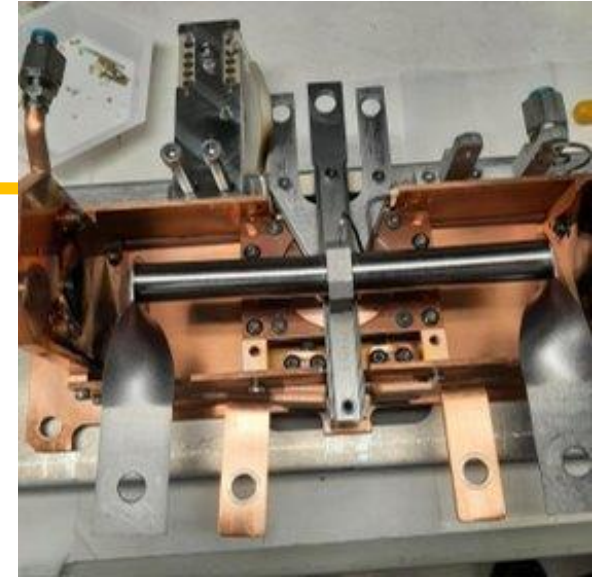

TiC#6 was revived in July (not something we have done before) and provided more beam than anticipated, allowing a GRIFFIN experiment first proposed in 1999 to be completed.

Goal #1: Test out changes to FEBIAD design

- Based on our understanding of the issues with the FEBIAD targets last year, new FEBIAD targets have:
 - Additional spacing added where possible to prevent shorts caused by thermal deformations
 - New anode wire routing and insulators to reduce the possibility of shorts destroying the insulation around it.
 - Repositioning of gas line insulator to reduce possibility of coating it
- These modifications worked, specifically the new anode wiring ran well for 3 weeks
- Still had one electrical fault on the HP target, but there were work arounds for this, to be investigated when the target is in the hot cell

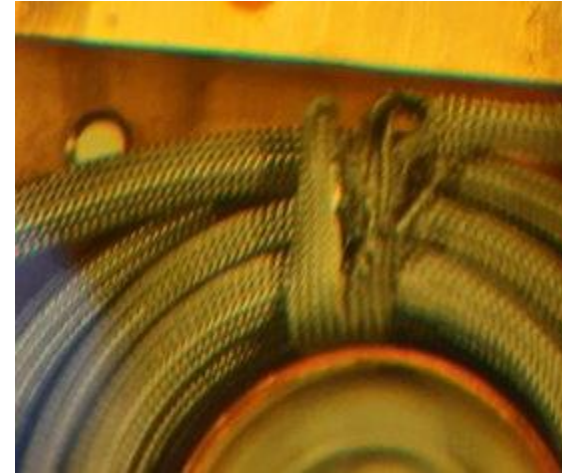

Old anode wire routing over the coil using fiberglass sleeve, which was destroyed by sparking in 2022

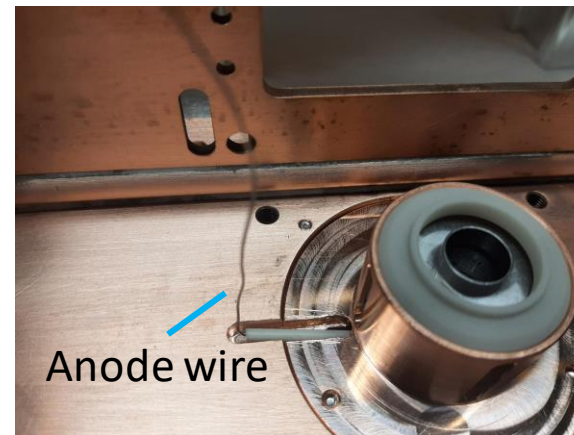

New anode wiring routed in machined trough under coil using custom ceramic insulators (not shown) in key spots

Goal #2 : FEBIAD parameter investigations

- Used a new HLA to investigate the parameter space of the FEBIAD, allowing us to find the optimal parameters for highest beam intensity
- Nominal parameters vs optimal parameters can be different by a factor of 4
- Also used the scan technique to investigate contamination reduction using the FEBIAD parameters. Results show this can alter the ratio of Ar/Cl by $\sim x2$
- Investigated the 2+ efficiency compared to 1+ efficiency – this was in the 3-5% range

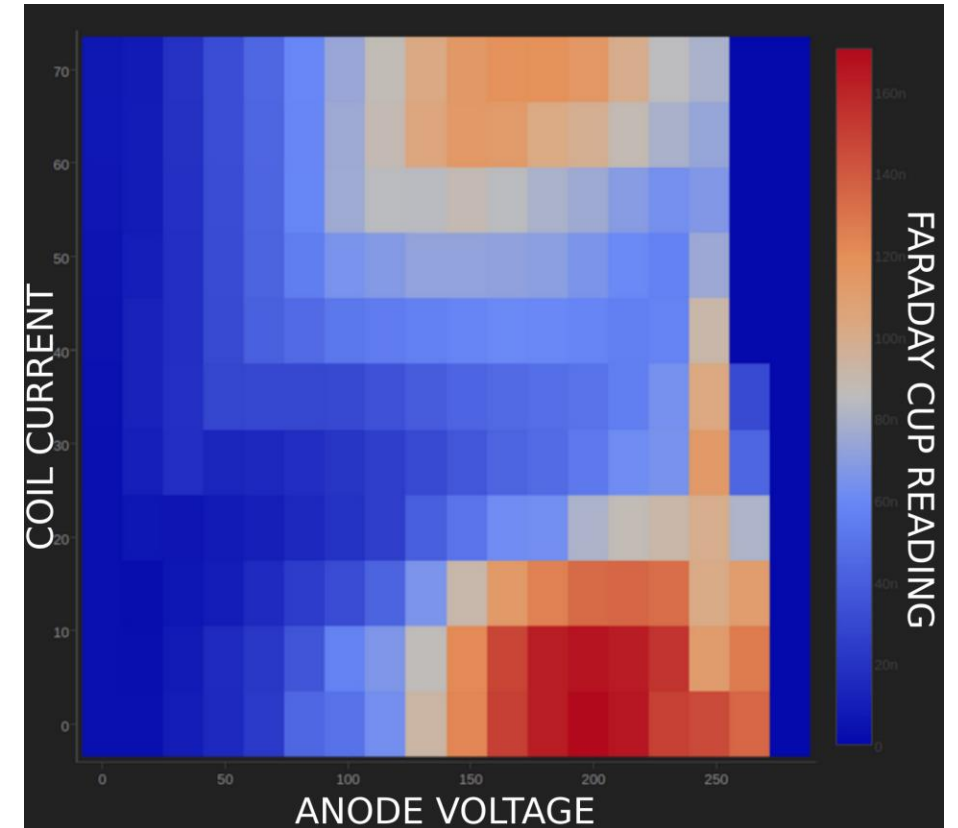

FEBIAD parameter scans conducted using new HLA from Spencer K. and Fernando M.

Goal #3: Experience with TiC material

- Elements/molecules measured:
 - Ar
 - Mg
 - Na
 - AlF
 - Cl
 - K
 - Al
 - CO
 - F
 - Ne
 - O
- New yields on TiC:
 - ^{15}O
 - ^{33}Cl
 - $^{17,19,20}\text{F}$
 - $^{27}\text{Al}^{20}\text{F}$
 - ^{23}Mg
 - $^{28}\text{Al}^{19}\text{F}$
- New information about conditioning of the material

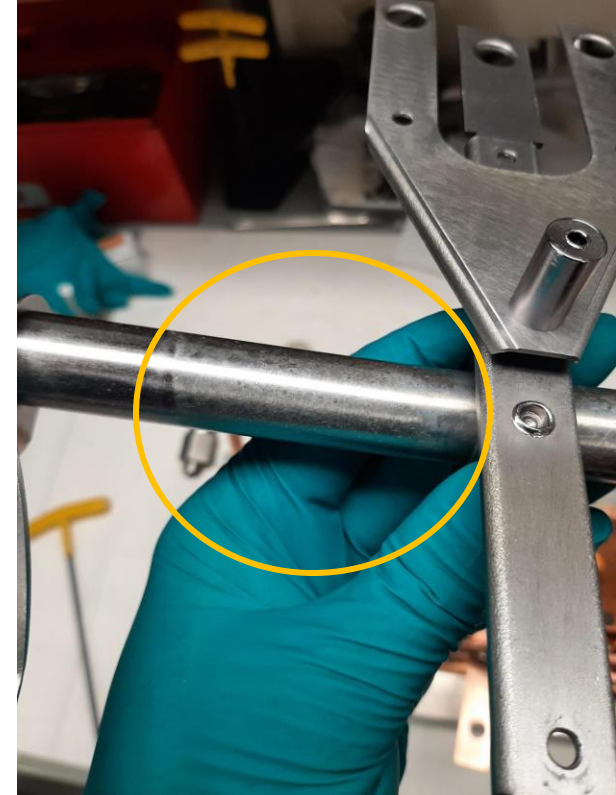

First LP TiC target container damaged in the test stand (replaced with a new target to go online)

Goal #4 : Check performance of LP target

- The LP target (TiC#5) did not perform well online.
- There were no obvious issues with it, but overall rates were very low.
- Investigations of the target in the hot cell after use showed the target container was quite damaged but not as bad as has been seen before. Conditioning and operation issues will be investigated offline.

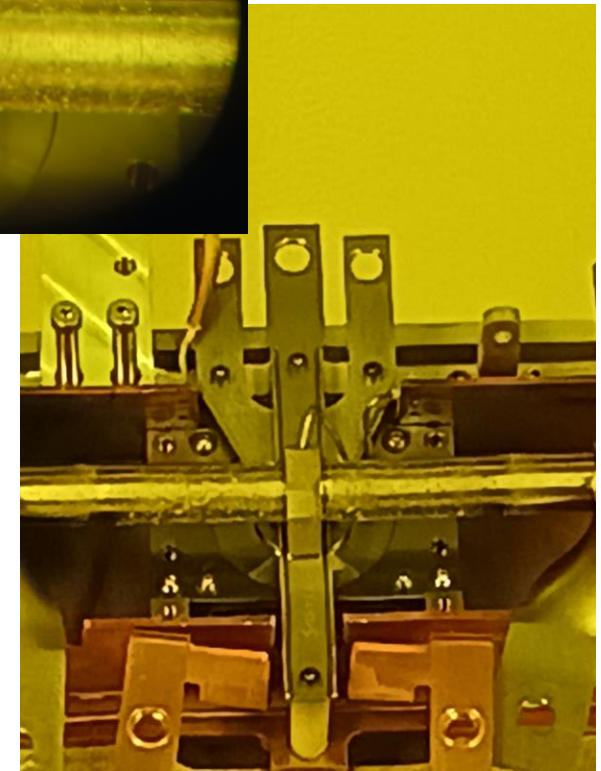
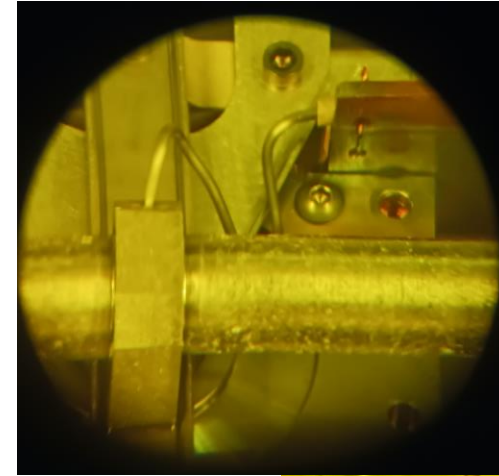

Beam Development Collaborations

- LOIs are the standard way of requesting beam development, however for more involved developments contact the Target and Ion Sources and Beam Delivery departments directly to discuss (you can email RIBdev@triumf.ca)
- Collaborative efforts are the best way to get complex beam development done:

Proton-to-neutron converter target was developed in collaboration with TITAN MR-ToF. The target was characterized and new mass measurements were made.

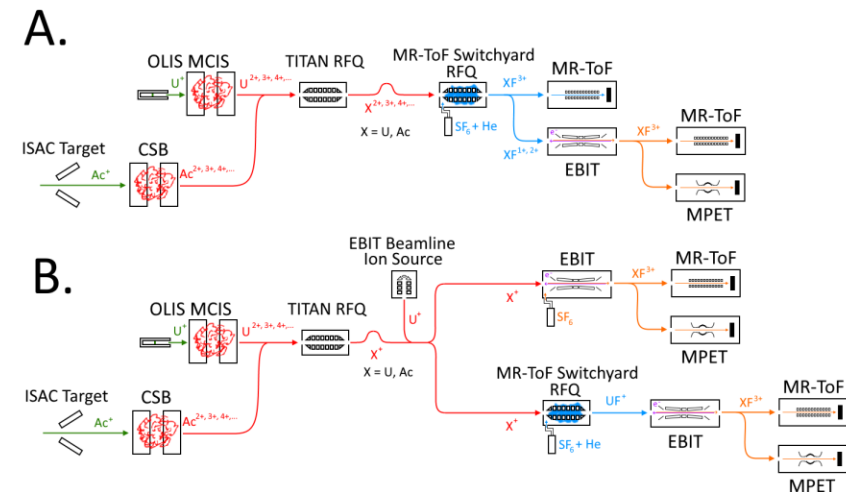
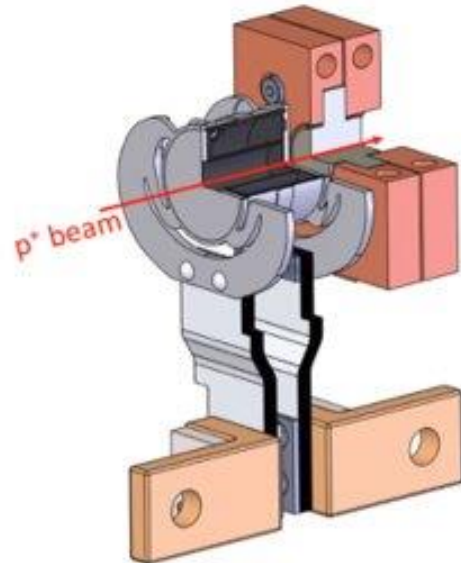

RadMol experiment working with targets and ion sources dept to develop an offline source, steer infrastructure developments and conduct proof-of-principle tests (image from RadMol).

New yields measured 2022-2023

New yields in 2022:

- $^{65,67-70}\text{Ni}$
- ^{232}Fr

Improved yields in 2022:

- $^{47,48,50,53}\text{K}$
- ^{75}Ga
- $^{110,112,118}\text{Ag}$
- $^{112,128,130}\text{In}$
- ^{128}Cs
- ^{211}Fr
- $^{211,232}\text{Ra}$
- ^{232}Ac

New yields in 2023 (on TiC):

- ^{15}O
- $^{17,19,20}\text{F}$
- ^{23}Mg
- ^{33}Cl
- $^{27}\text{Al}^{20}\text{F}$
- $^{28}\text{Al}^{19}\text{F}$

New CSB yields:

- ^{132}Sn 17-25+
- ^{134}Sn 18-24+

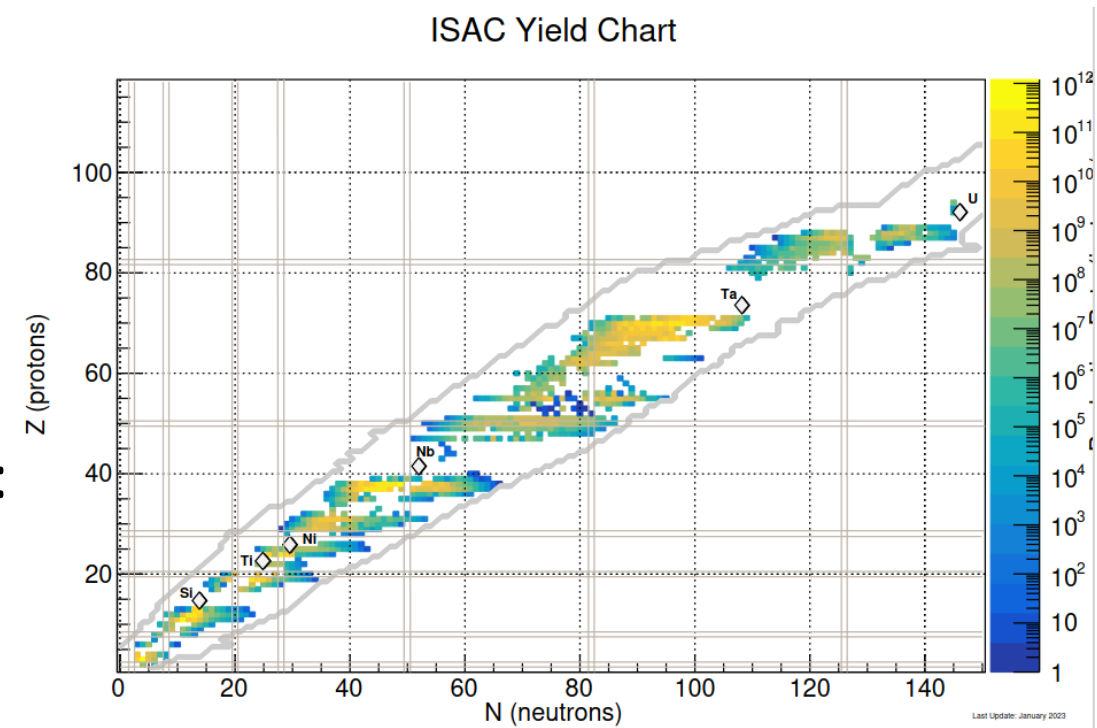

From P. Kunz

OLIS Updates

- OLIS used to deliver ^{133}Cs , ^{31}P and ^{140}Ce recently
- Work ongoing to diagnose issues with ^9Be , ^{24}Mg , ^{40}Ca , $^{63/65}\text{Cu}$ and ^{27}Al
 - Development time for Mg coming up
- Investigations of plasma conditions coupled to ion-gas chemistry in ECR source (new gas mixing apparatus developed)
 - Stable molecular beam developments for RadMol and ISAC
- Redesign of OLIS and LE optics to make predictable and repeatable tuning possible (long term project)

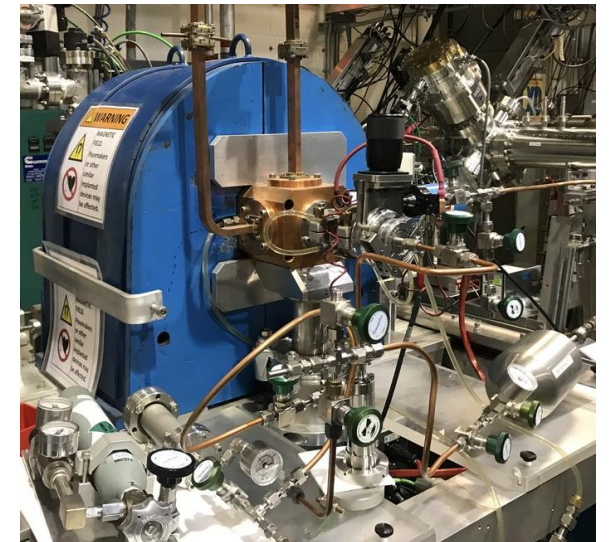
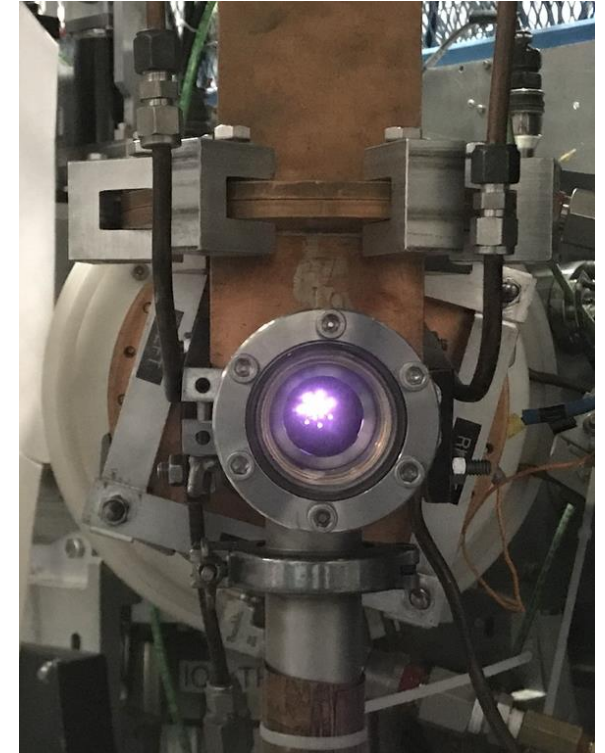

Beam Delivery Developments

- Machine development shifts are being phased in at ISAC

- Model Coupled Accelerator Tuning application for simplified machine tuning and reduced tuning time.
- Bayesian optimization tune correction development, enables multiparameter optimization of designated matching sections in the linac and beamlines.

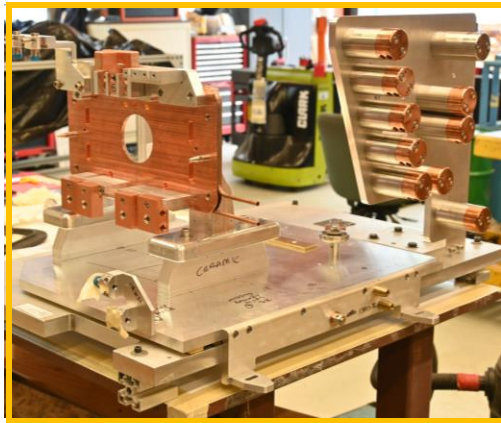

Image and info: Olivier Shelbaya

- RF booster used this year to compensate for target module voltage and deliver RIB to DRAGON
 - Stability and transmission issues being addressed

TM3 Refurbishment

Service tray assembly complete, ready for soldering of the service cap lines



Source tray assembled and alignment jig verified with the FaroArm. Ready for tube bending to begin.

Goal is to be ready for commissioning by end of this year.

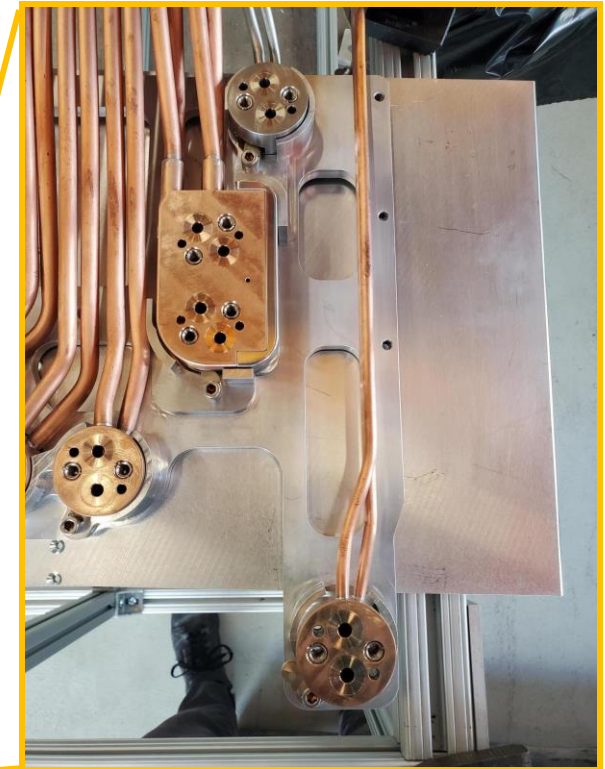
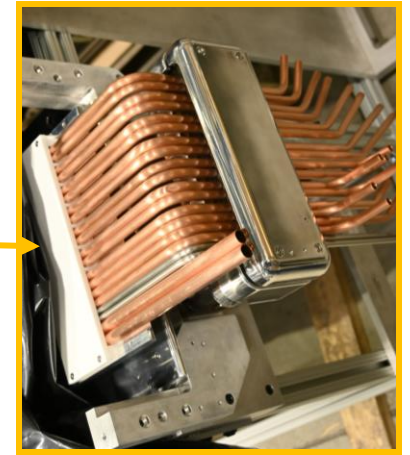
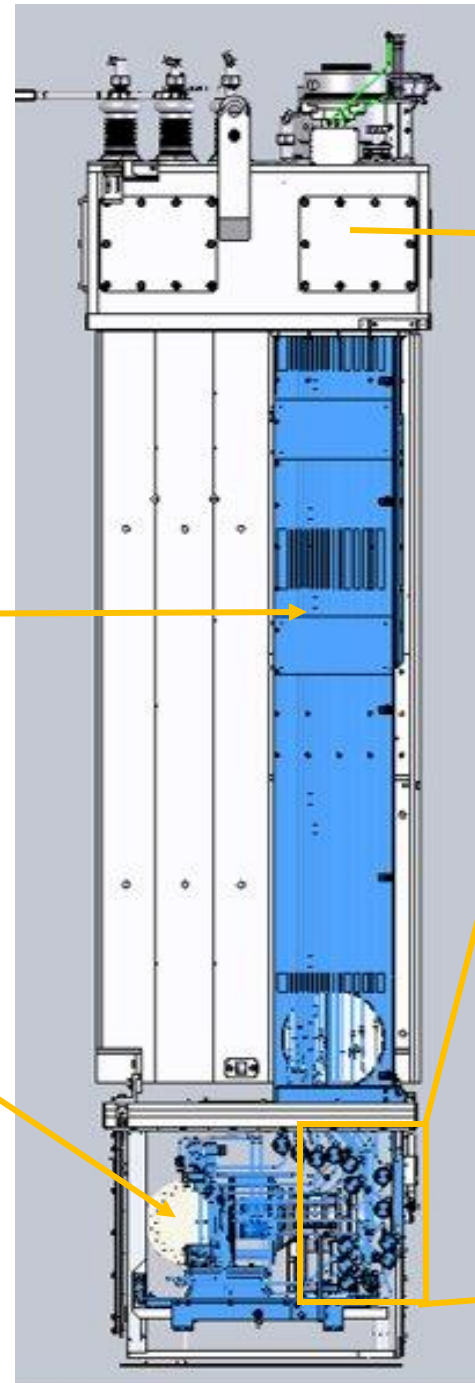

ISAC Target Infrastructure Upgrades

Cooling water system upgrades successfully tested:

- In the past there have been delays in p+ delivery due to the quick drop in the resistivity of the cooling water with the first protons of the year.
- Investigations and discussions with collaborators suggested a solution which involves injection N with a small admixture of H into the circulating water.
- This was prototyped over the shutdown and used successfully this year.
- Final work to make the system permanent is underway.

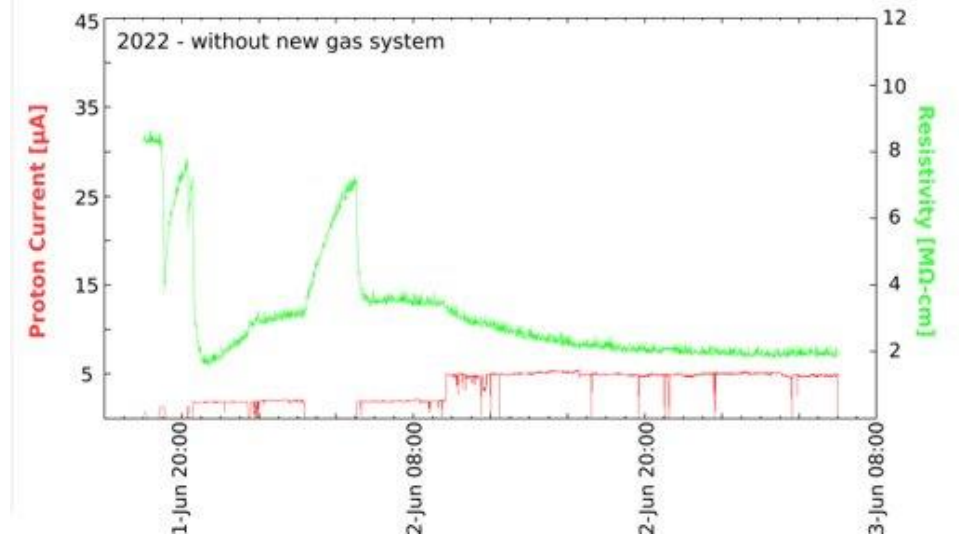
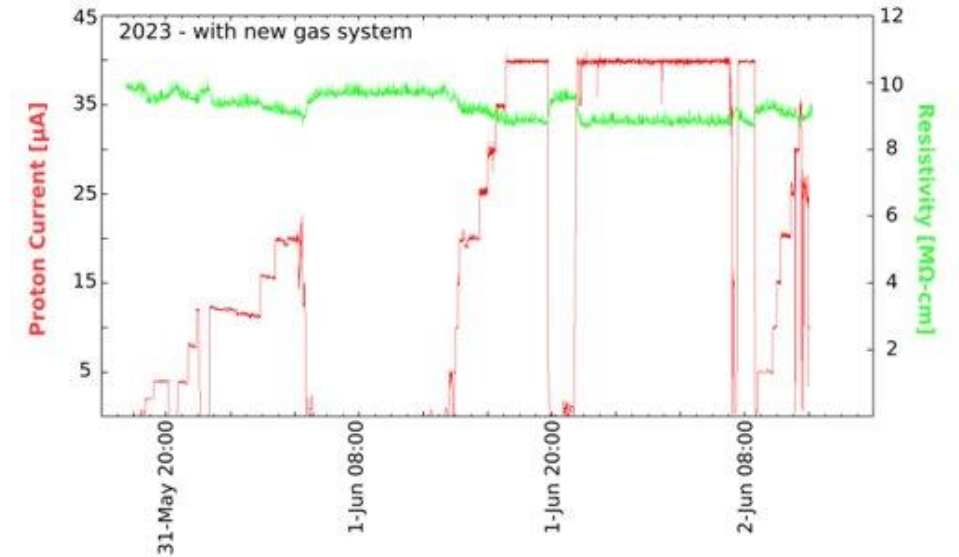

Other Resources

- Sign up on the Beam Delivery mailing list for weekly Beam Delivery Updates on all facilities
- Read the Users Newsletter for progress updates and plans
- Use RIBdev@triumf.ca to communicate ideas and requests

Thank you!
Merci!

