

---

# Pion and muon beams at PSI, performance and plans

Andreas Knecht  
Paul Scherrer Institute

DND 2020  
Zoom  
5. 11. 2020

---

# Location of Paul Scherrer Institute



# Muons & Pions at PSI

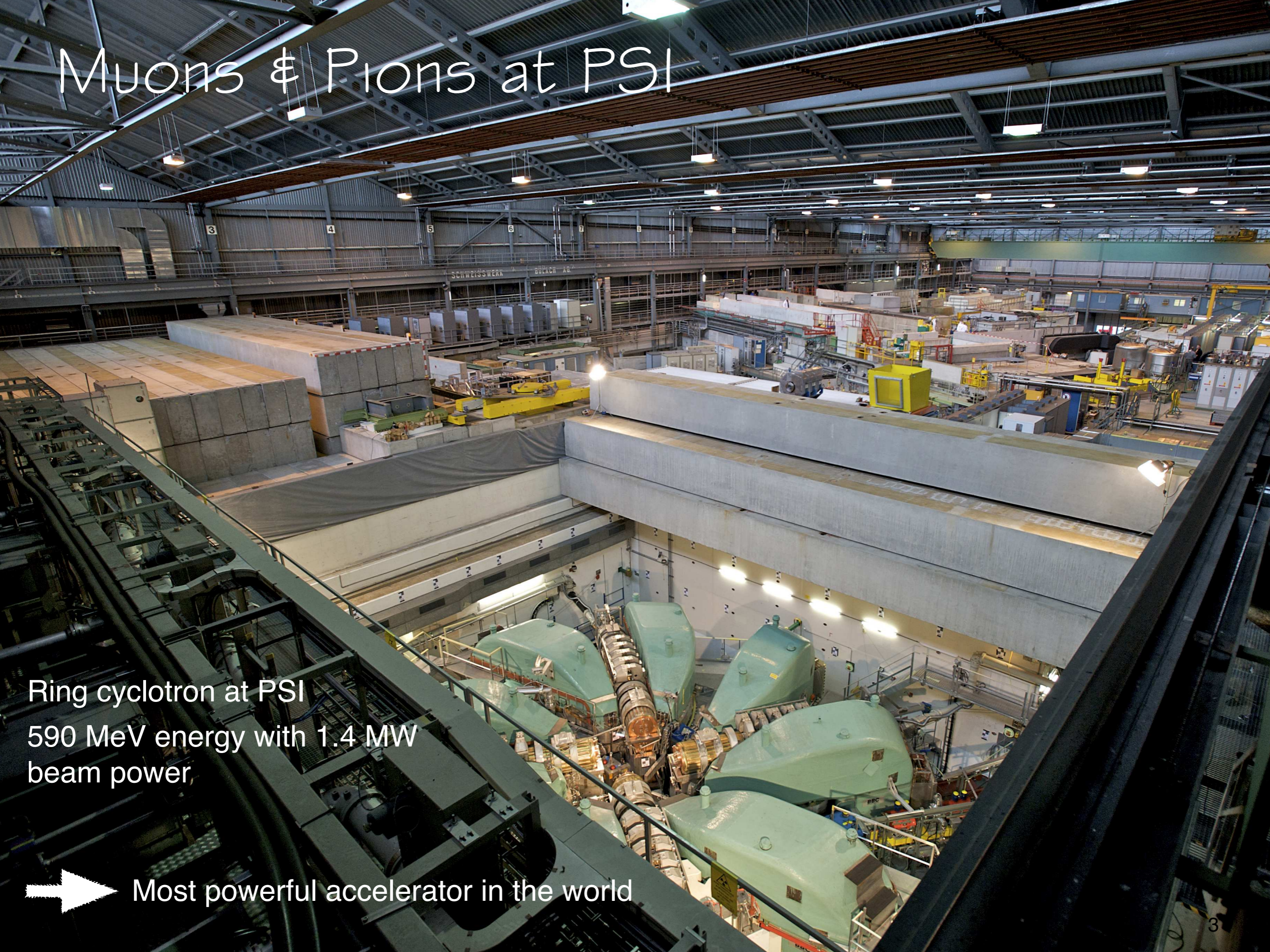

Ring cyclotron at PSI  
590 MeV energy with 1.4 MW  
beam power,

➔ Most powerful accelerator in the world

# PSI Proton Accelerator HIPA

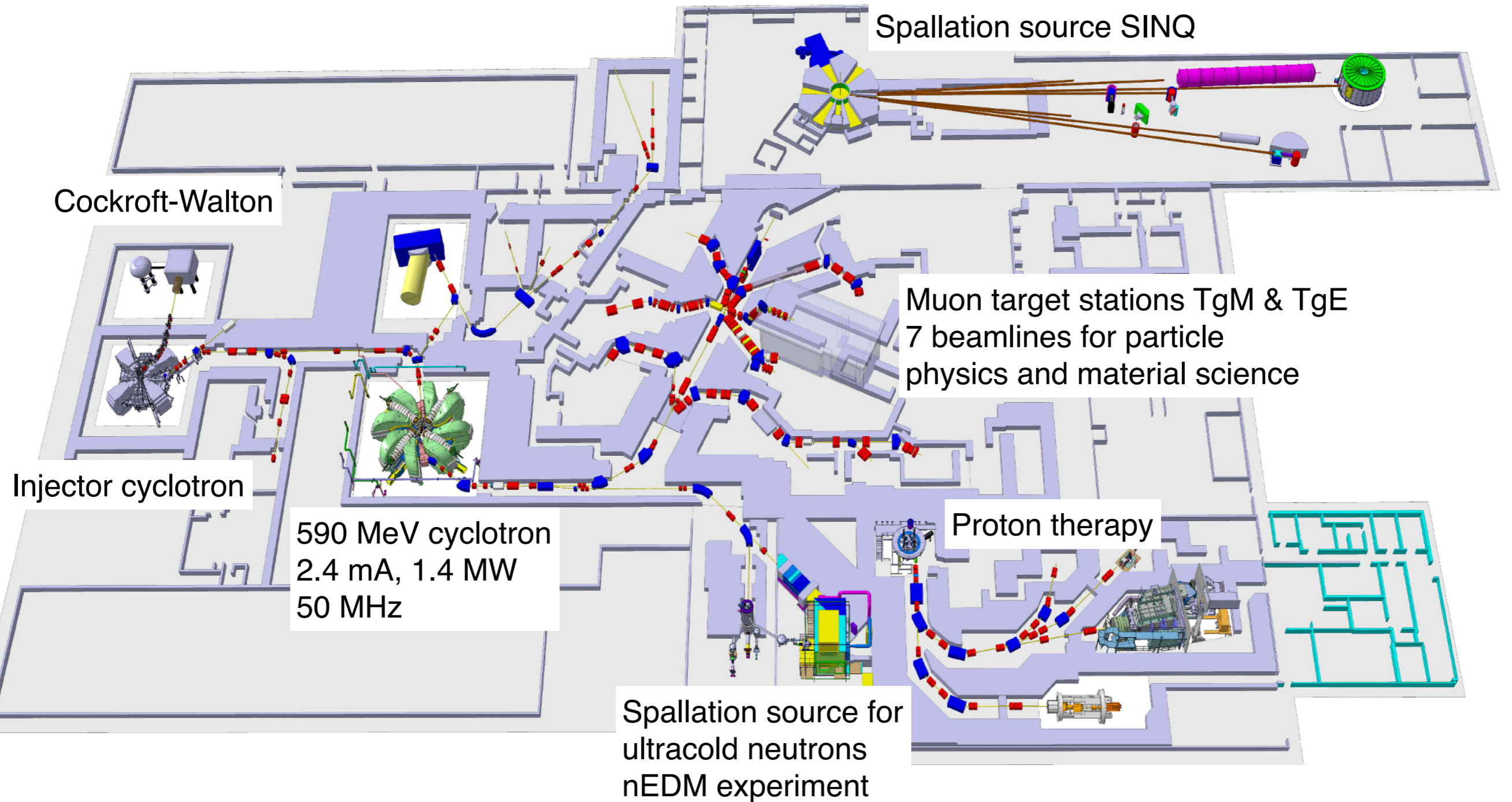

# Production Target TgE

- ▶ 40 mm polycrystalline graphite
- ▶ ~40 kW power deposition
- ▶ Temperature 1700 K
- ▶ Radiation cooled @ 1 turn/s
- ▶ Beam loss 12% (+18% from scattering)

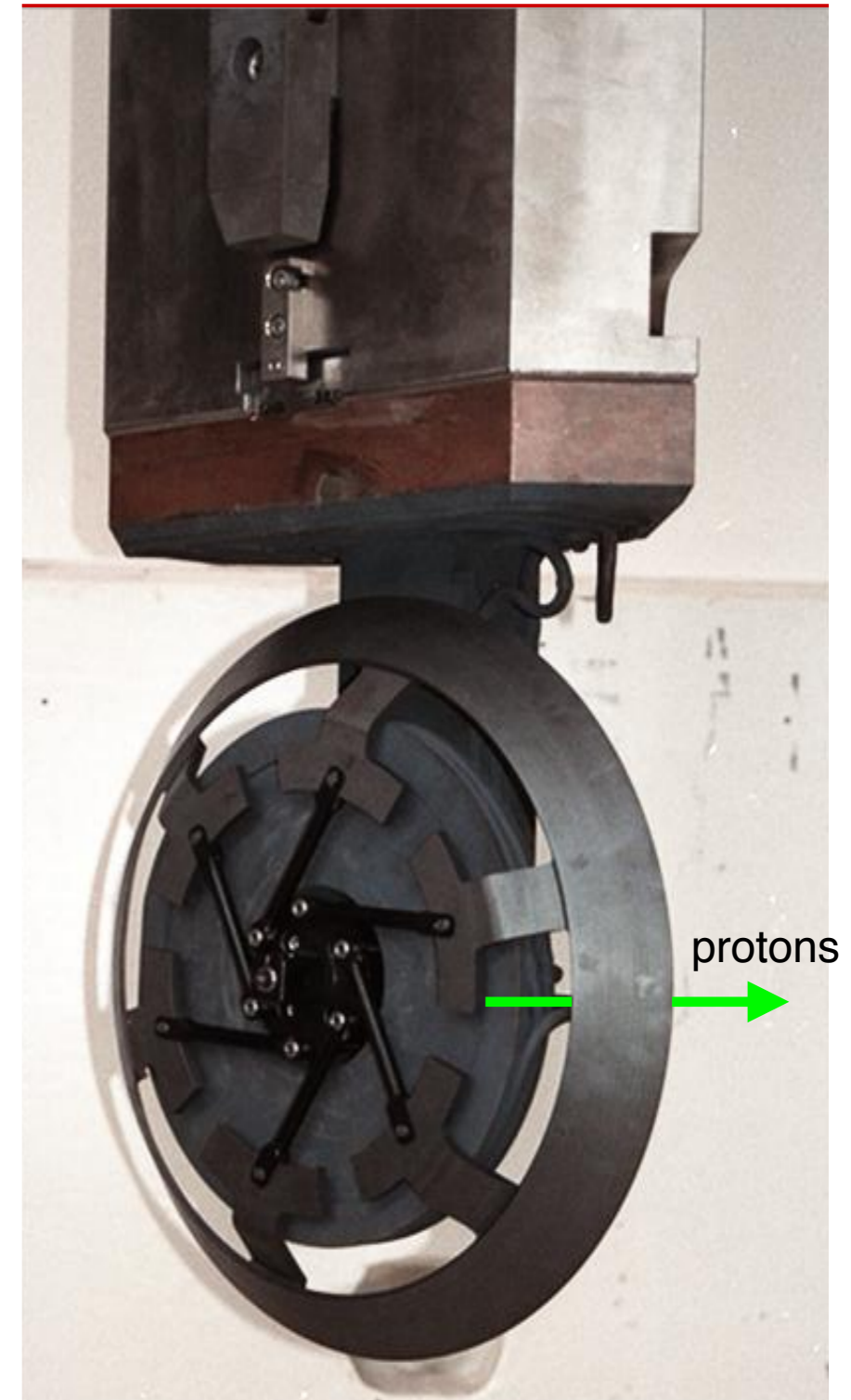

# Pions, surface and cloud muons

- ▶ Pions produced through the interaction of the protons with the target
- ▶ Low-energy muon beam lines typically tuned to surface- $\mu^+$  at  $\sim 28$  MeV/c
- ▶ Contribution from cloud muons at similar momentum about 100x smaller
- ▶ Negative muons only available as cloud muons
- ▶ 50 MHz beam structure for pions and cloud muons
- ▶ For surface muons: time structure of cyclotron smeared out by pion lifetime  $\rightarrow$  DC muon beams

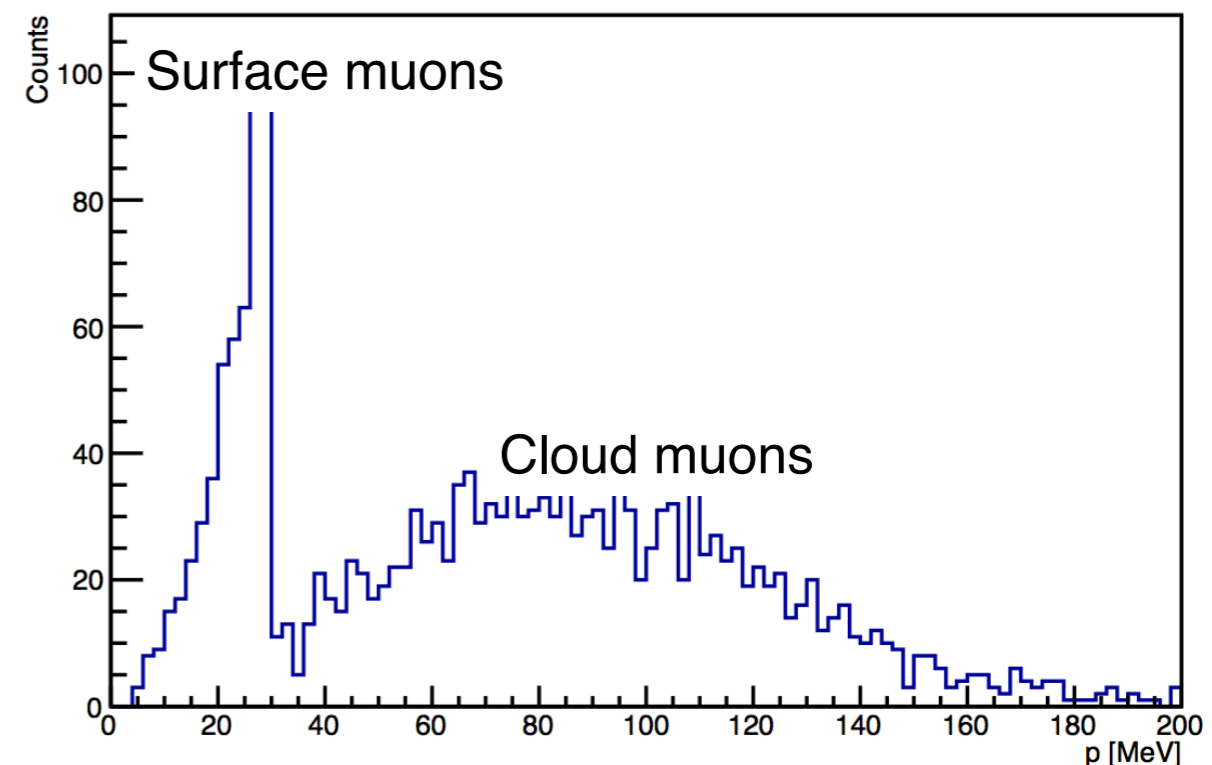
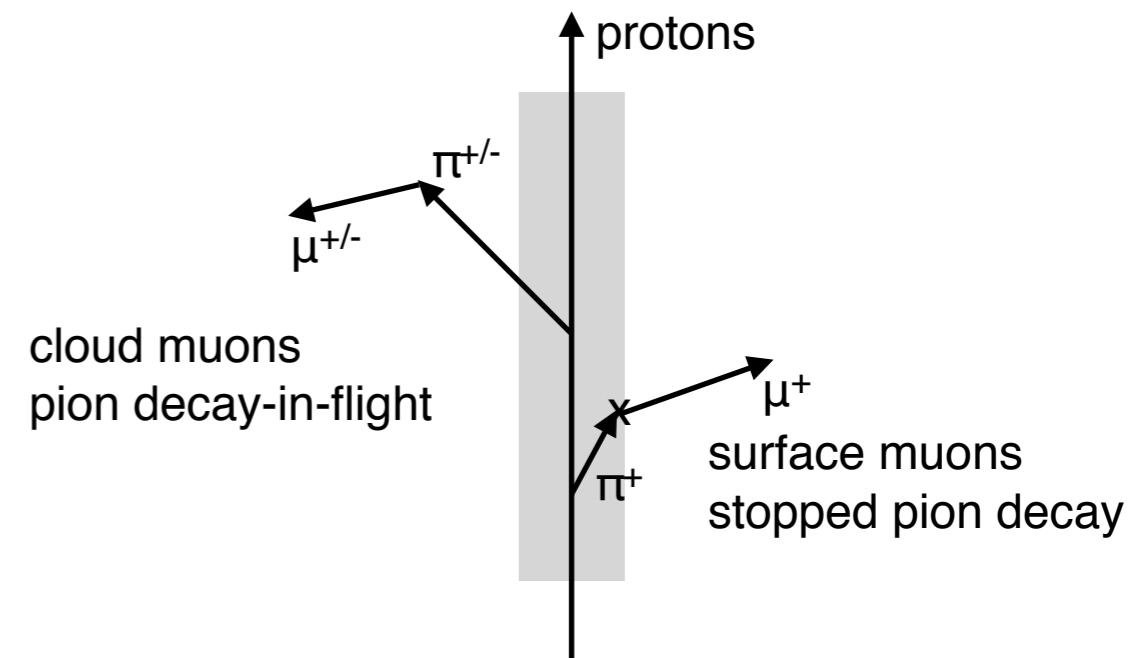
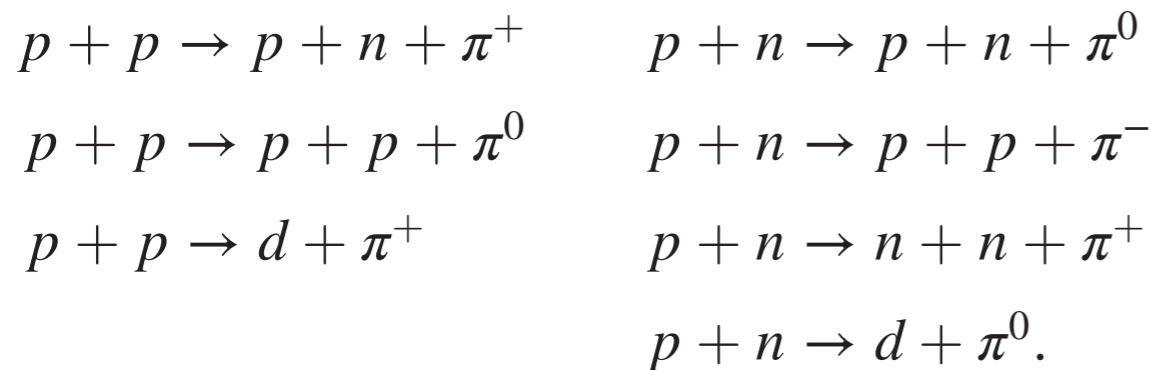

---

# Performance of pion beams at PSI

# Possible locations for pion experiments

- ▶ PiE5:
  - ▶ Highest-rate beamline available to particle physics
  - ▶ Home of MEG, Mu3e, Lamb Shift, piHe, ...
- ▶ PiE1:
  - ▶ Shared with muSR
  - ▶ Home of MuSun, PIBETA, PEN, ...
- ▶ PiE3:
  - ▶ Belonging to muSR (high-field muSR)

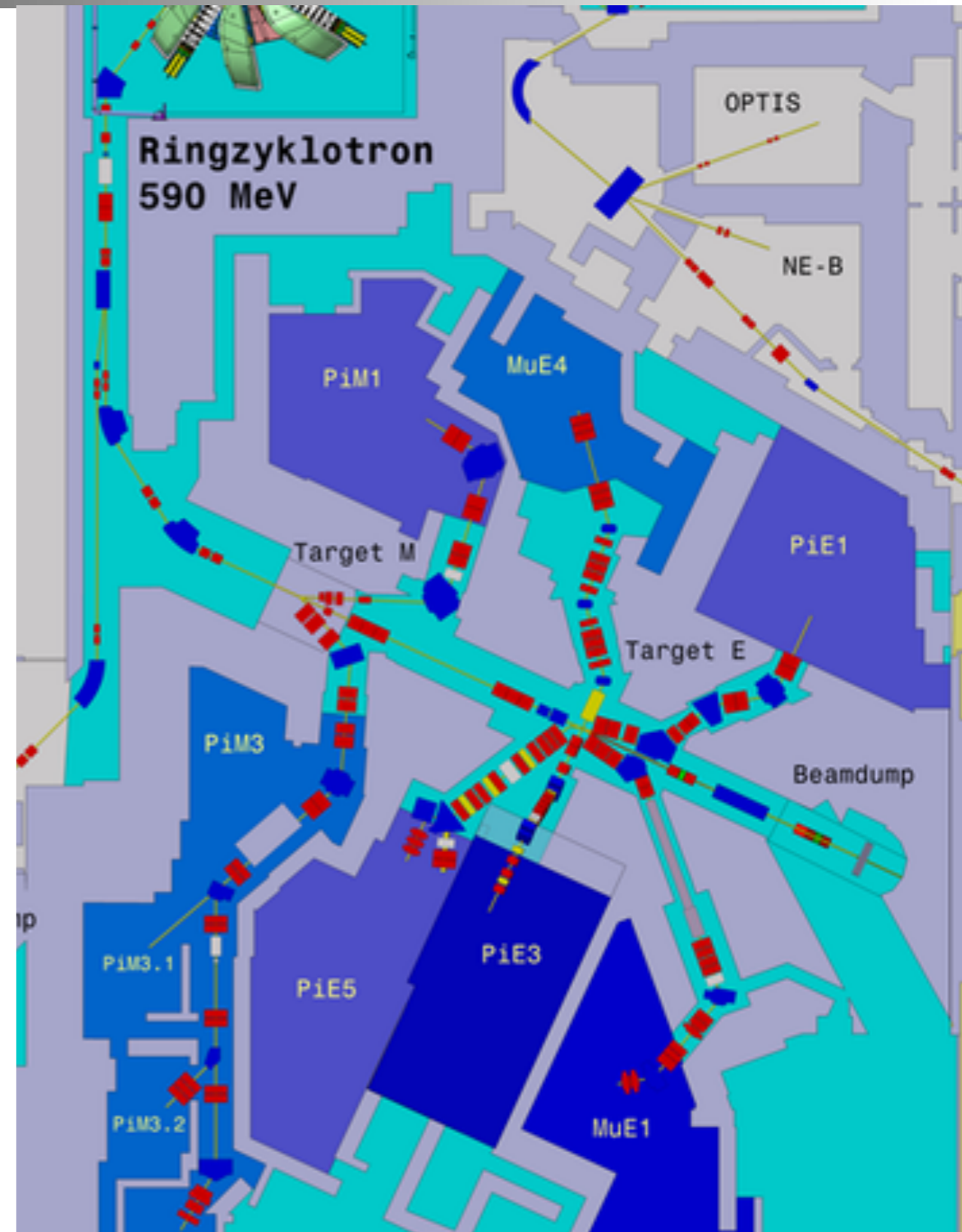



- ▶ Low-momentum, low-resolution, high-acceptance beamline
- ▶ Particle rates given in the plot typically too high: However, up to  $10^9$  pi $^{\pm}$ /s at 100 MeV/c and full momentum acceptance possible

Length	10.4 m
Solide angle	150 msr
Momentum acceptance (FWHM)	10 %
Momentum resolution (FWHM)	2 %
Spot size (FWHM)	15 mm horizontal 20 mm vertical
Angular divergence (FWHM)	450 mrad horizontal 120 mrad vertical

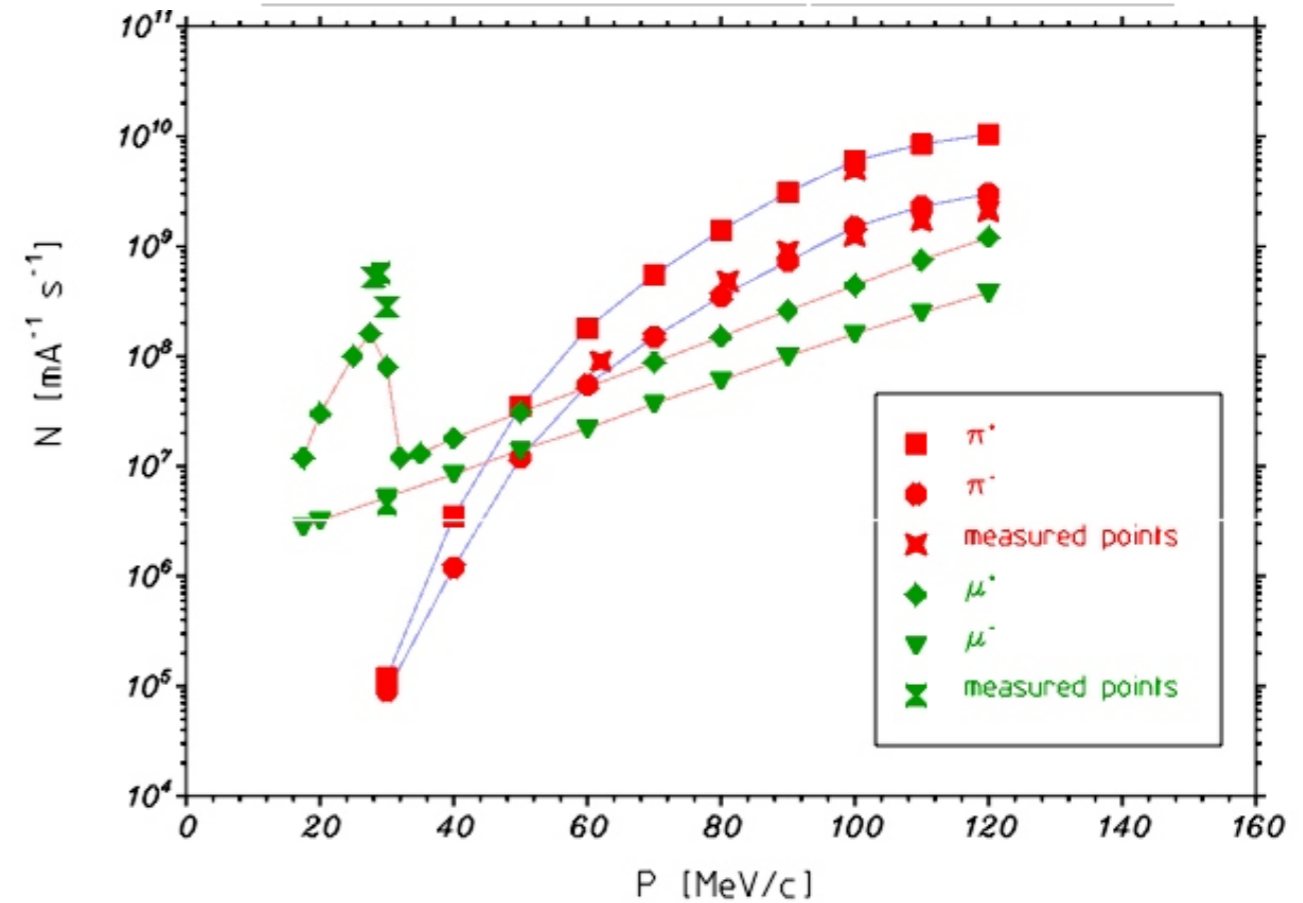
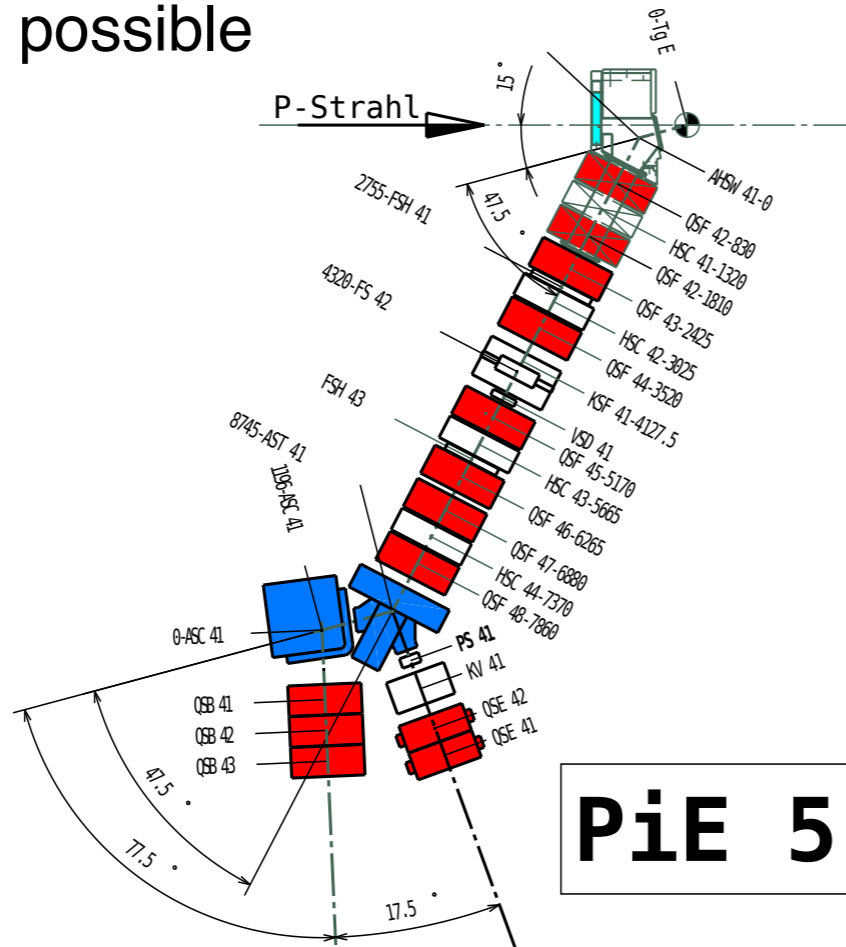

# Recent pion experiment in P1E5: $\pi$ He

## First laser spectroscopy of a pionic atom at PSI

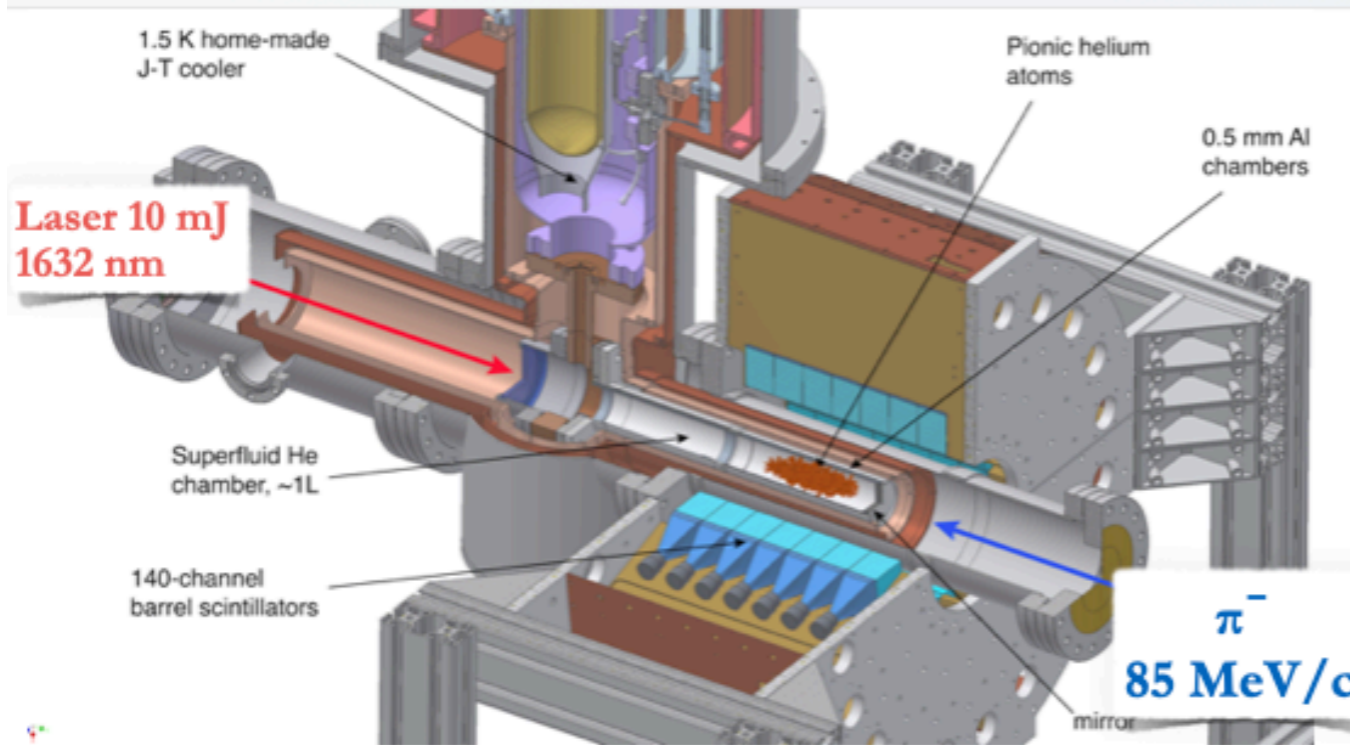

nature

Article | Published: 06 May 2020

### Laser spectroscopy of pionic helium atoms

Masaki Hori, Hossein Aghai-Khozani, Anna Sótér, Andreas Dax & Daniel Barna

Nature 581, 37–41(2020) | Cite this article

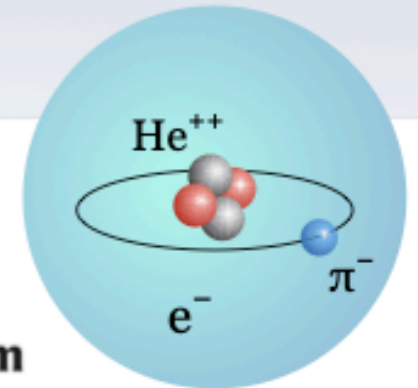

PAUL SCHERRER INSTITUT

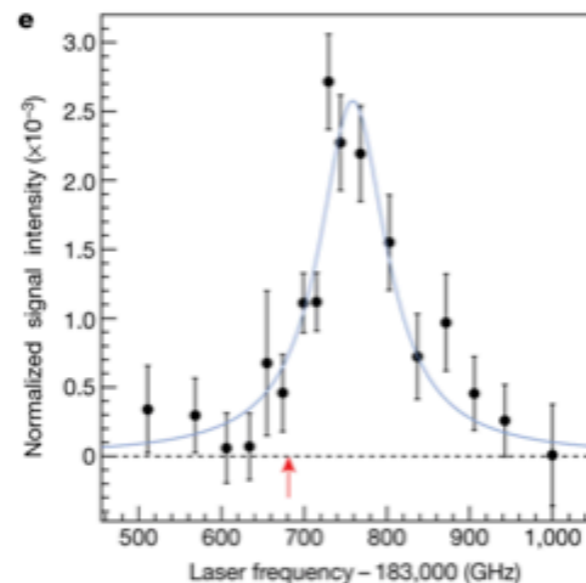
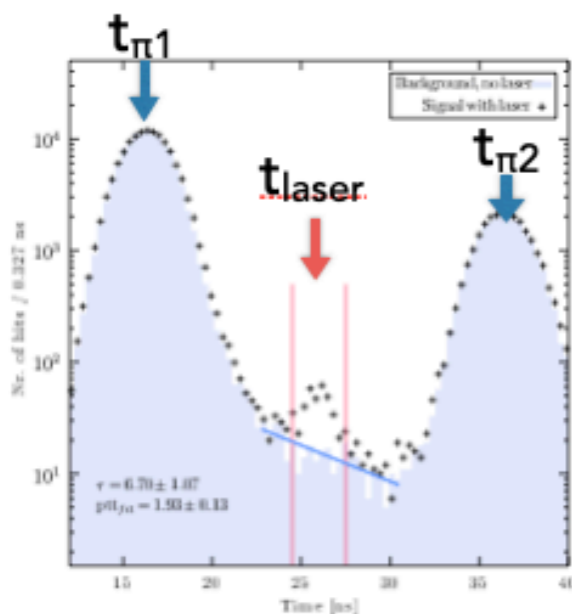
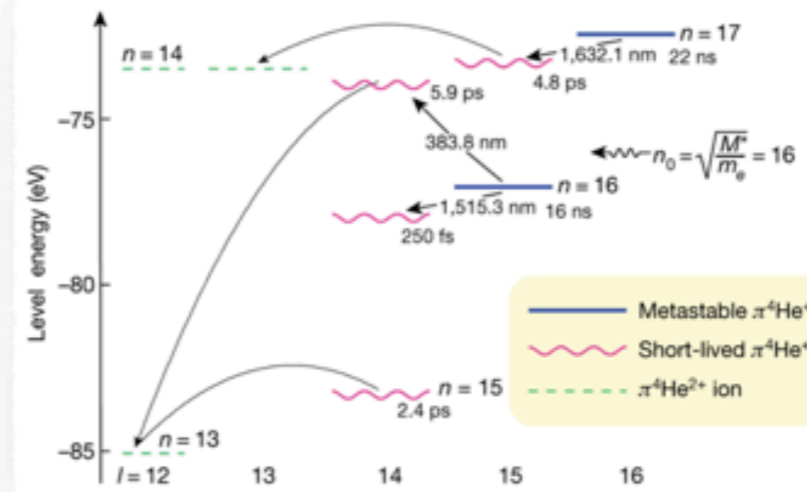

- ▶ A metastable state was discovered, with  $\sim 7$  ns lifetime
- ▶ First laser spectroscopy of a mesonic atom was carried out at PSI
- ▶ High chance for a narrow transition  $(17, 16) \rightarrow (16, 15)$  to determine  $m_{\pi}/m_e$  to **10 ppb precision**

- ▶ Beamline quite a bit extended compared to “normal” configuration
- ▶ Use of long separator to suppress electron background
  - ▶ Factor 4 more pion rate with high-voltage off

At target position: 2D Gaussian profile with FWHMs of 14 and 22 mm, and 8% momentum bite at 85 MeV/c momentum

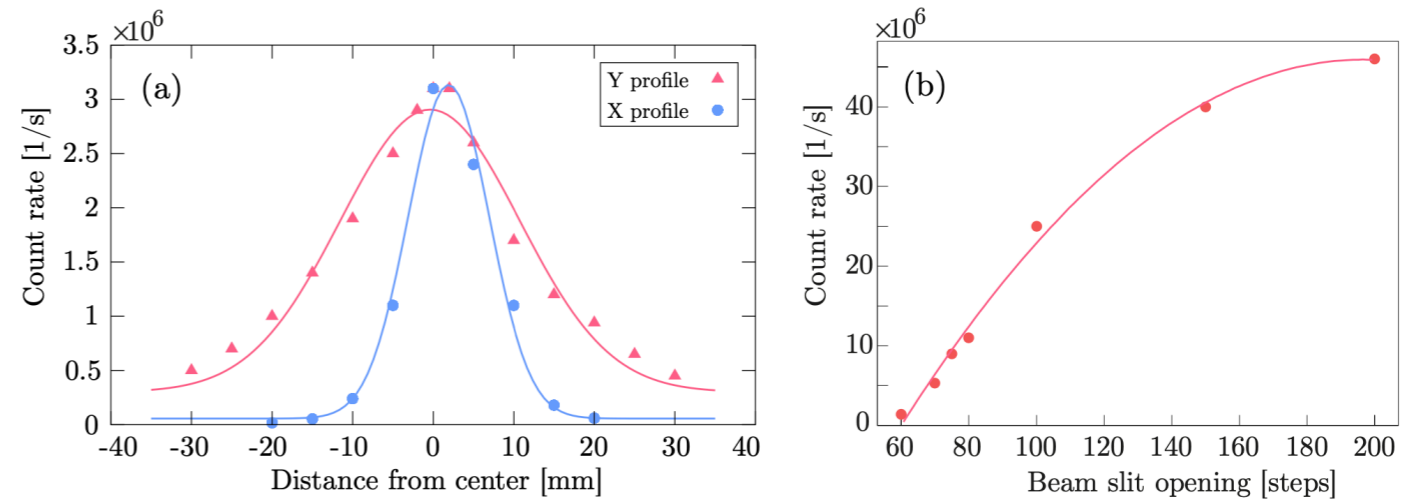
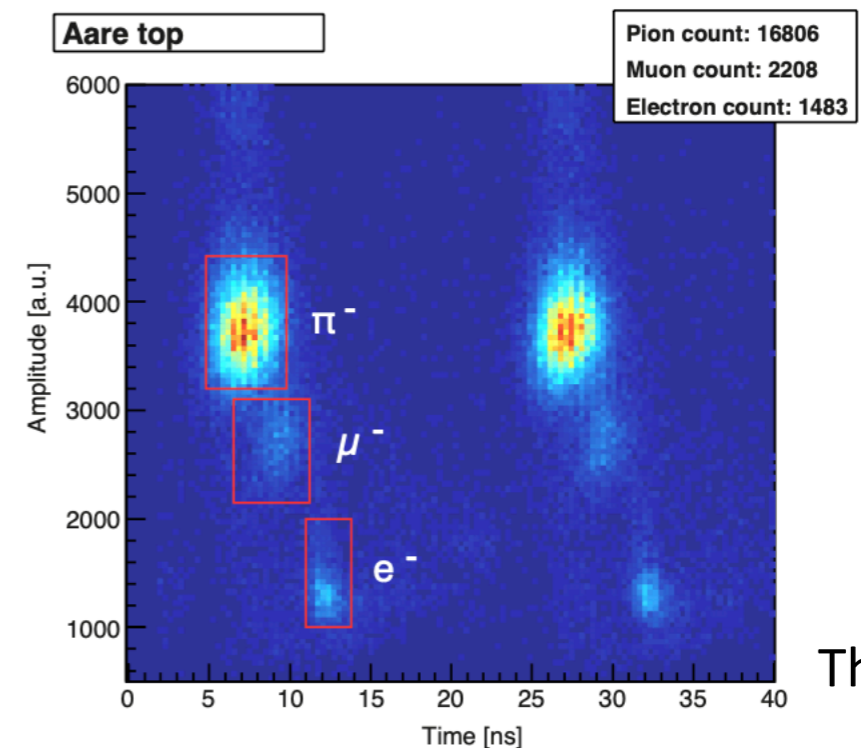

Figure 4.20: (a) Beam profile measured  $\sim 30$  cm upstream of the target position with the small volume  $5 \times 5 \times 3$  mm remotely controlled movable counter. (b) Count rate in function of the beam slit opening (in steps of the motor of the slit)



Thesis A. Soter

- ▶ High-momentum, high-resolution, low-acceptance beamline

**PIE 1**

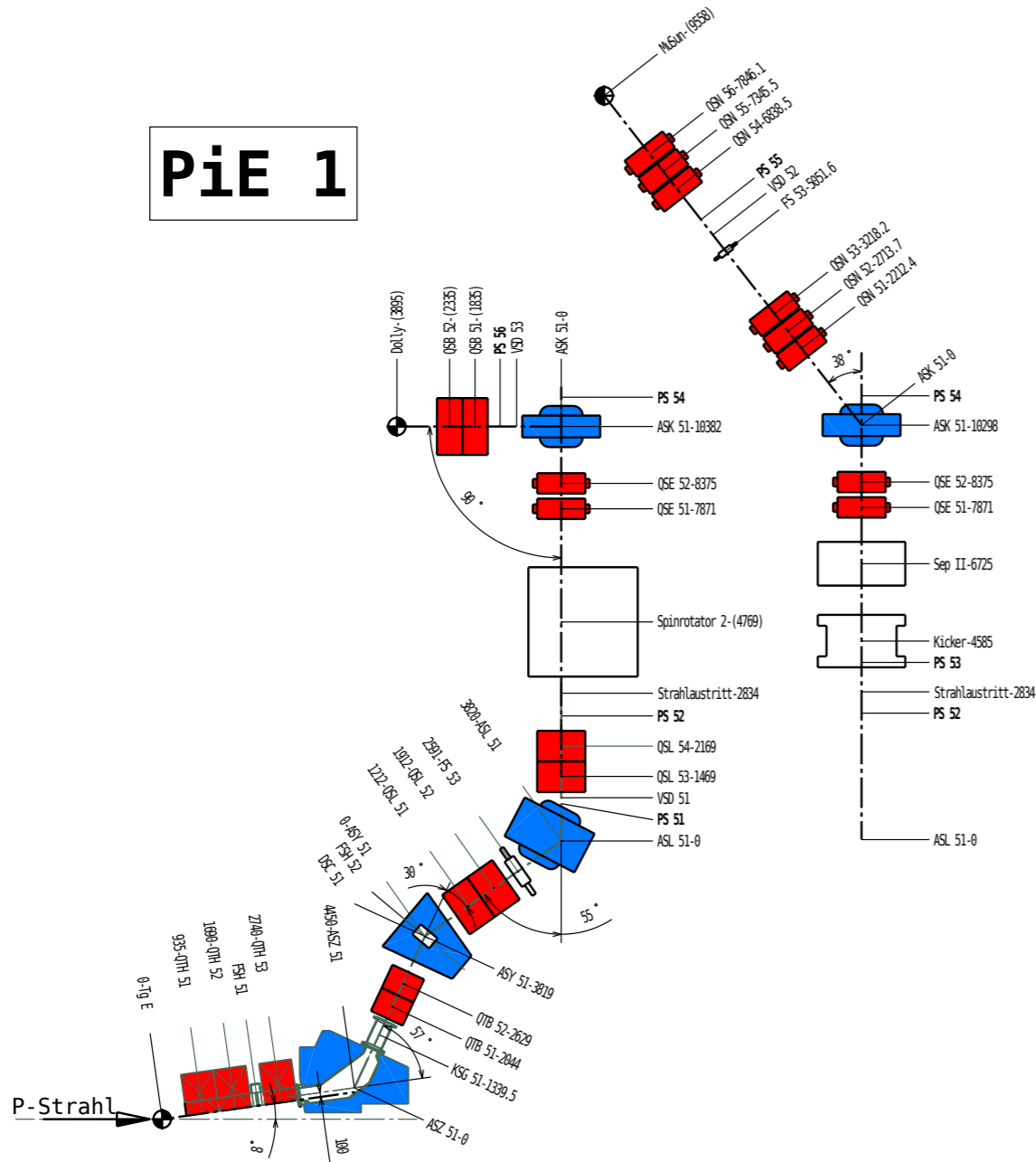

Mode	A	B
Length [m]	16	16
Max. momentum [MeV/c]	280	500
Solide angle [msr]	32	13
Momentum acceptance (FWHM)	7.8 %	8.0 %
Momentum resolution (FWHM)	0.8 %	0.26 %

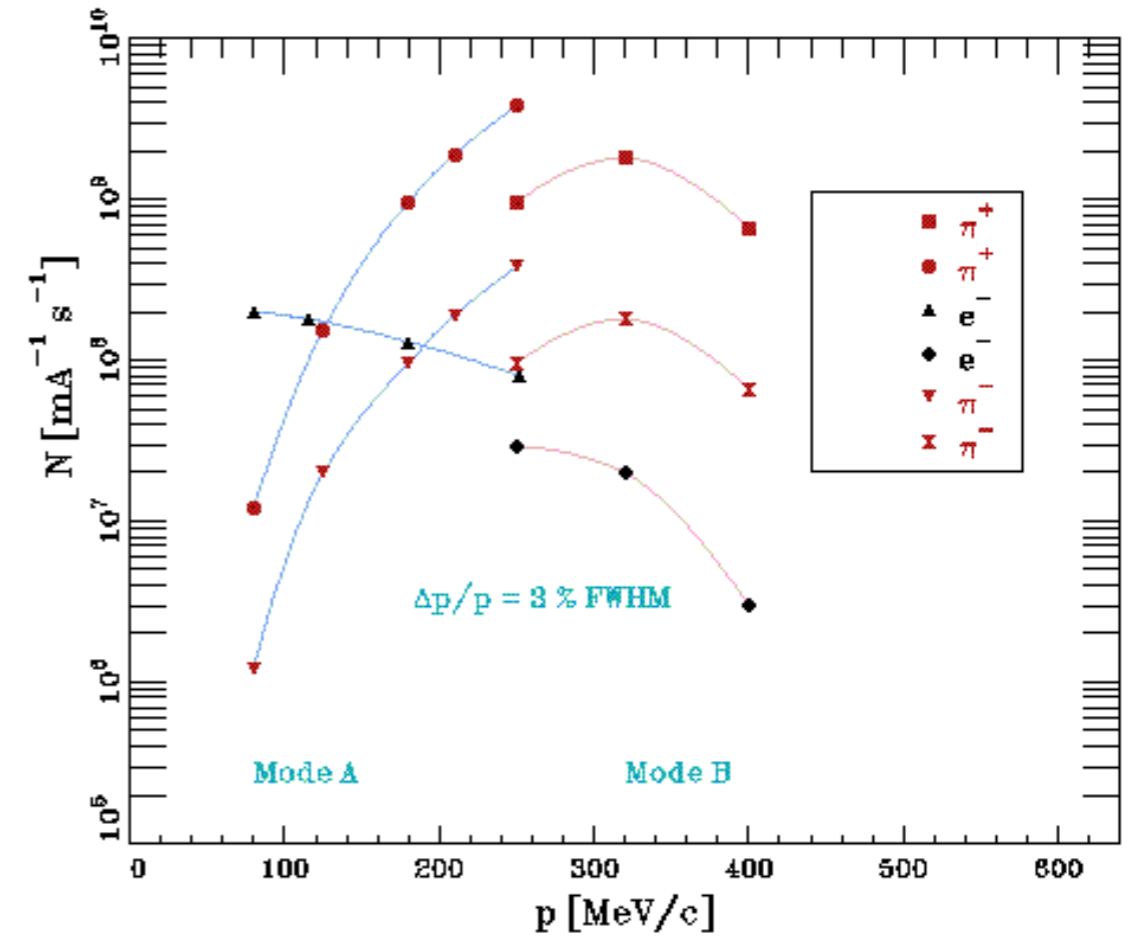

# PIBETA, PEN at PiE1

- ▶ PIBETA:
  - ▶  $\sim 10^6$   $\pi^\pm$ /s at 113 MeV/c (1% momentum bite, 1.7 mA proton current, 60 mm TgE)
  - ▶ Positrons separated through differential energy loss in 4 mm thick carbon degrader mounted upstream
  - ▶ PID at active target through TOF
  
- ▶ PEN: few  $10^4$   $\pi^\pm$ /s at 70-85 MeV/c

PEN in the front part of PiE1

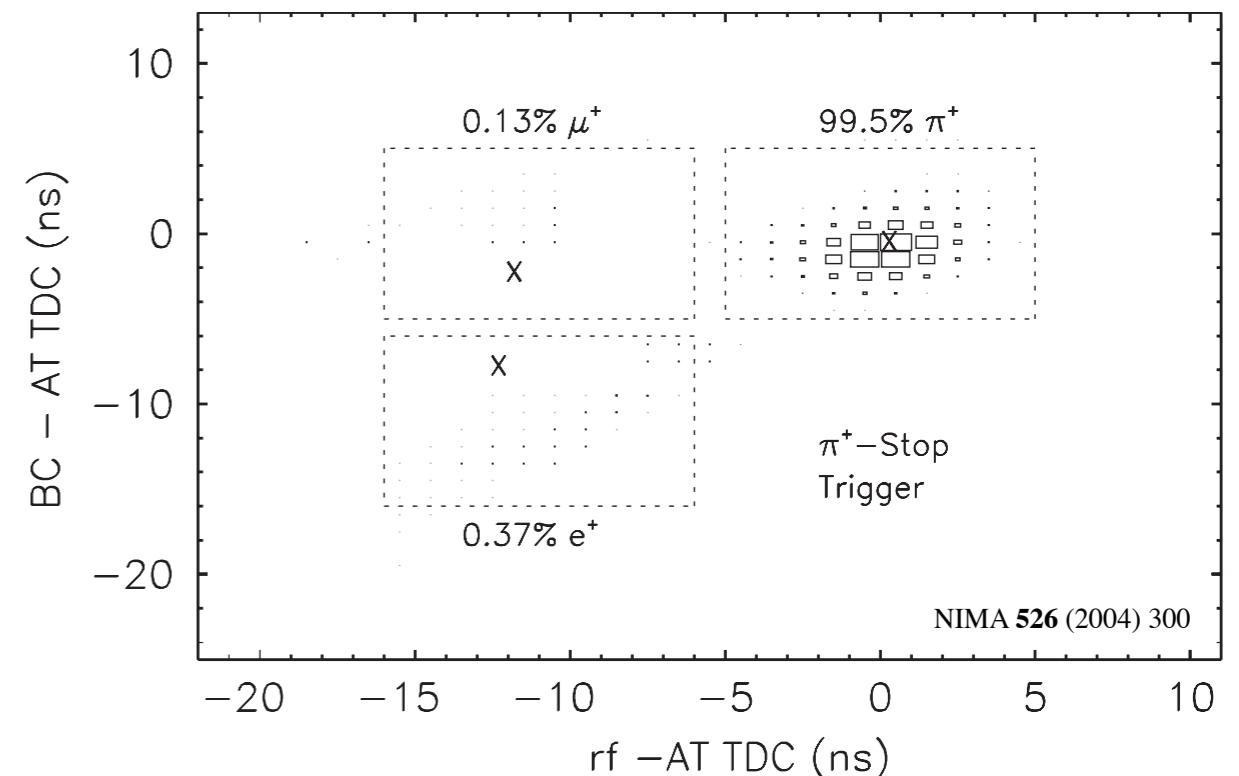
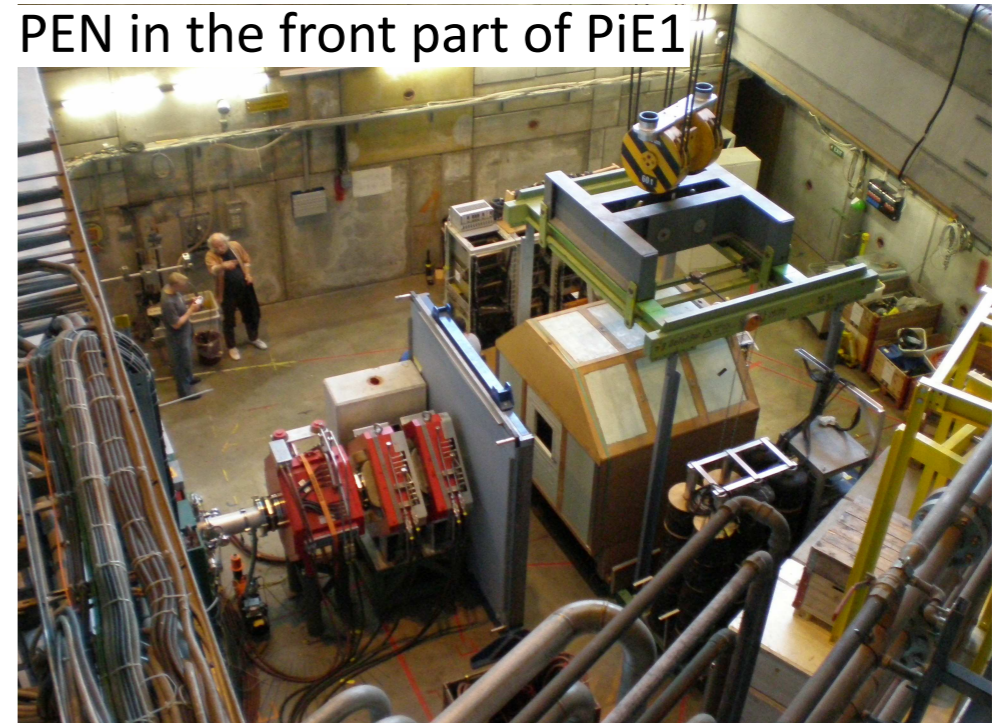

# Beamline for a future experiment?

- ▶  $\pi \rightarrow e \nu$ :
  - ▶ PiE1 is a possibility
  - ▶ Extrapolating from the rates achieved in PIBETA it should be possible to reach the required rate
  - ▶ Would be good to perform some first rate measurements
  
- ▶  $\pi \rightarrow \pi^0 e \nu$ :
  - ▶ Only PiE5 is an option
  - ▶ Based on rates measured by piHe, should be possible to obtain required rate
  
- ▶ Staged approach? First  $\pi \rightarrow e \nu$  in PiE1 and then  $\pi \rightarrow \pi^0 e \nu$  in PiE5?

"I estimate that the  $\pi \rightarrow e \nu$  experiment would optimally run at roughly  $2E5$  Hz of pions with a beam of  $P \sim 75$  MeV/c with  $dp/p \sim \pm 1\%$  and a spot size  $\sim 2$  cm dia. This would result in  $3E8$   $\pi \rightarrow e \nu$  events in  $3E7$  s of operation with a 50% acceptance. PIENU ran at  $5E4$  Hz and PEN at a much lower rate.

For  $\pi \rightarrow \pi^0 e \nu$ , the beam stop rate would have to be higher,  $\sim 2E7$  Hz. Here  $75$  MeV/c with larger  $dp/p$ , say  $\sim \pm 3\%$  may be adequate, yielding  $3E6$  piB events in  $3E7$  s with 50% acceptance. PEN piB ran at  $E6$  Hz (115 MeV/c)."

D. Bryman

---

Beam developments at PSI:

HIMB Project → goal of delivering  $10^{10}$  surface- $\mu^+$ /s

---

# Floorplan PSI

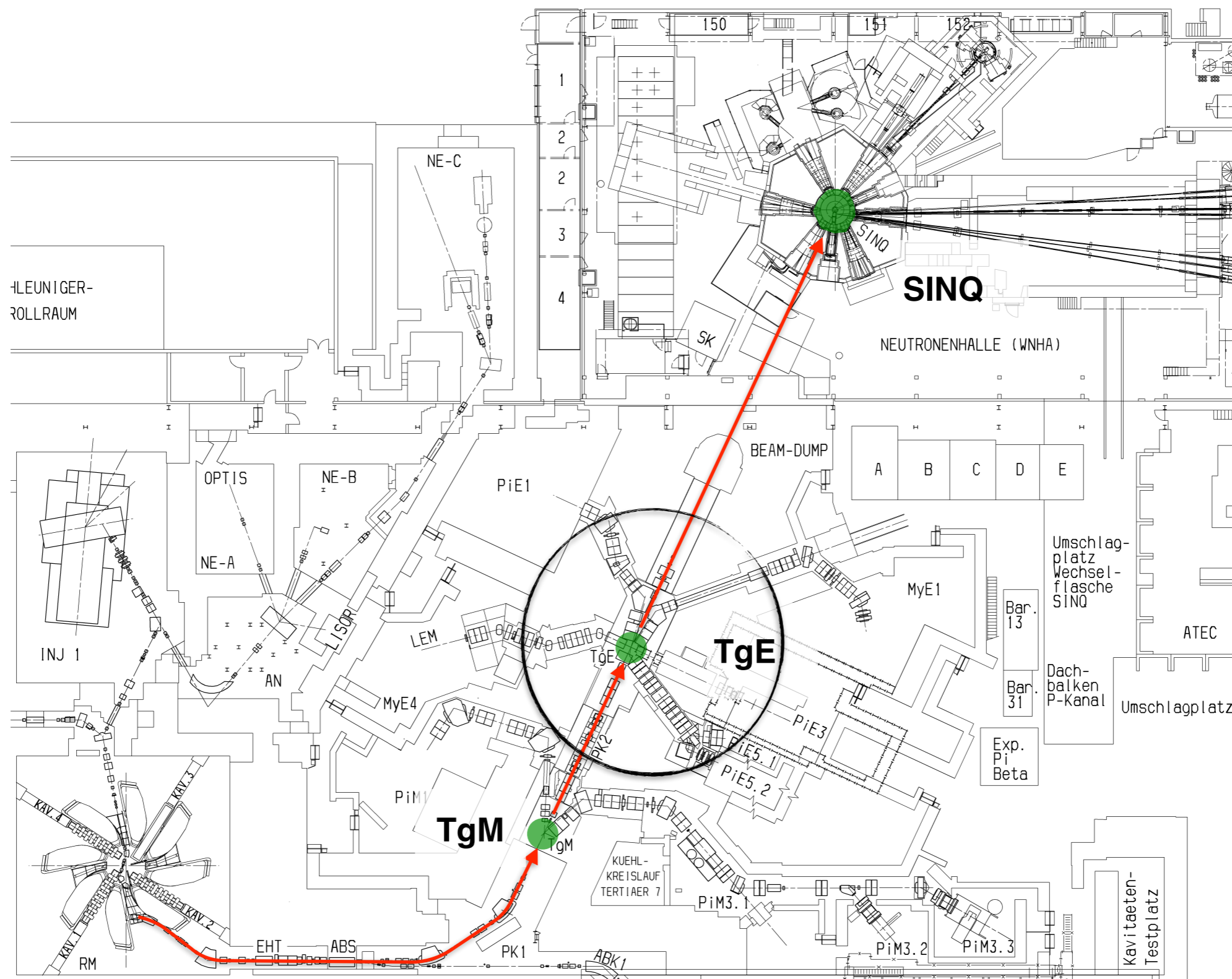



# HIMB Slanted Target Design

- ▶ Change of TgE geometry to increase surface muon rates for all connected beamlines
- ▶ Increase safety margin for “missing” TgE with proton beam

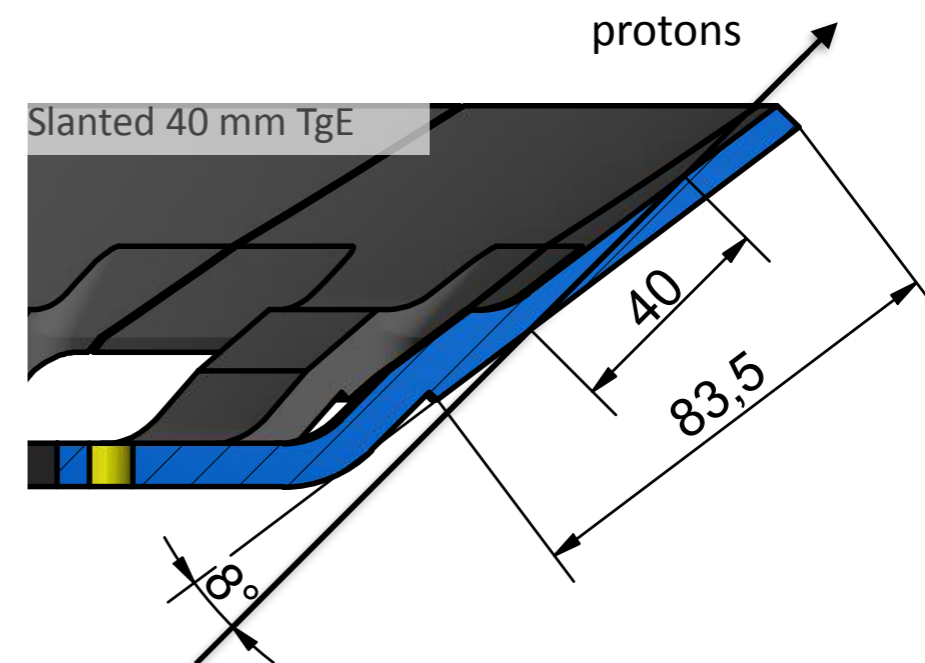
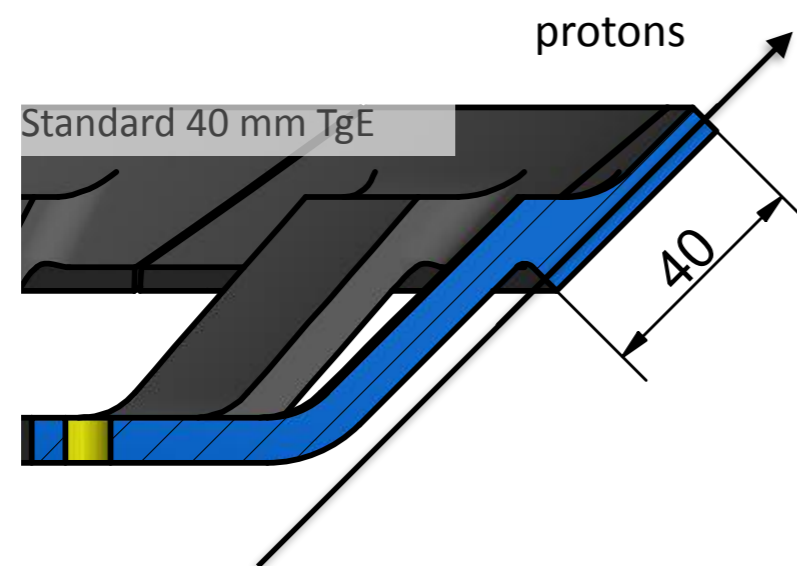

# HIMB Slanted Target Tests

- ▶ HIMB 40 mm slanted target installed on 25. 11. 2019

## Muon beam rates:

- ▶ 40-50% increase in surface muon rate measured in  $\mu E4$ ,  $\pi E5$ ,  $\pi E3$  and  $\pi E1$  ( $\mu E1$  not affected as it relies on pion collection)
- ▶ Consistent with simulation to within 10%

→ 40 mm slanted target as good or better than 60 mm standard target!

## Proton beam impact:

- ▶ Setup of proton beam well under control
- ▶ Increased safety margins confirmed

## Future:

- ▶ To be seen: Impact of higher thermal stress on long term stability of target wheel. HIMB target has been running all of 2020 until recent target change due to failure of bearings.

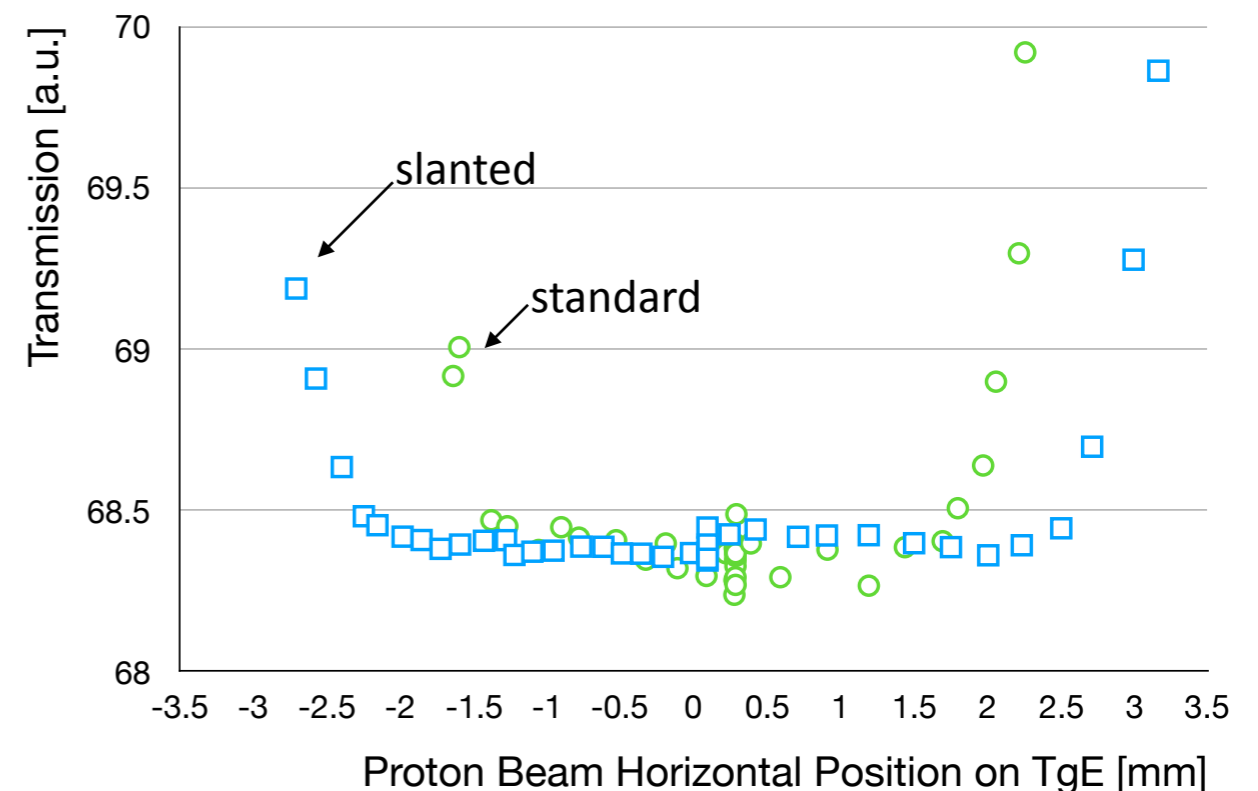
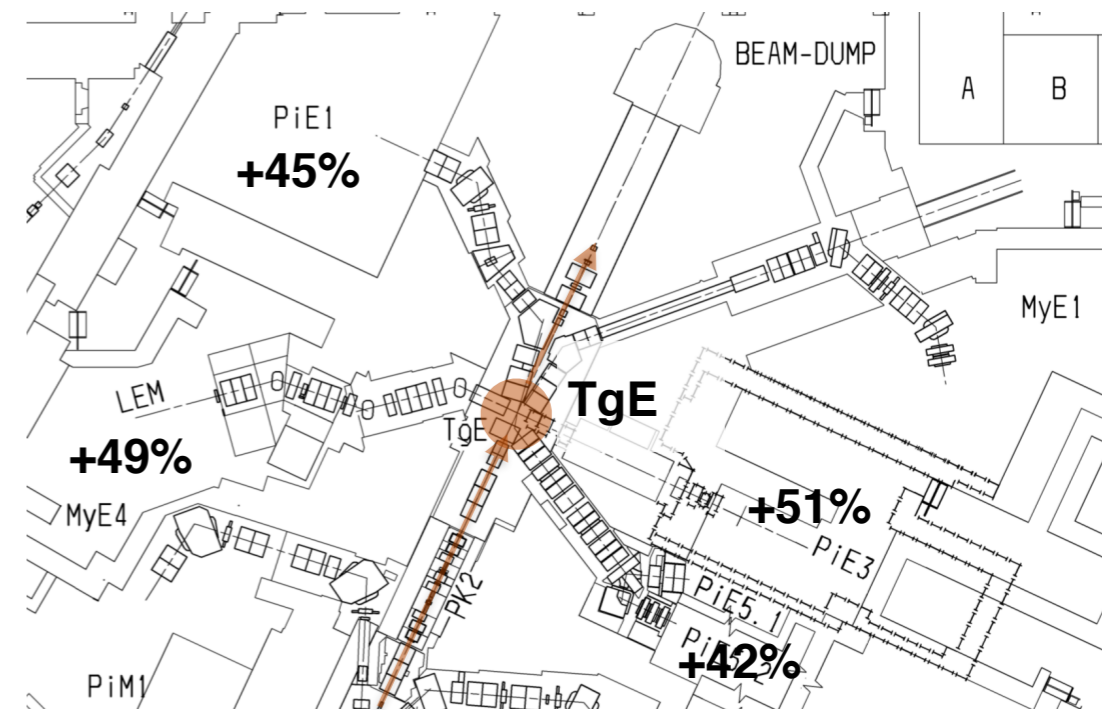

# Floorplan PSI

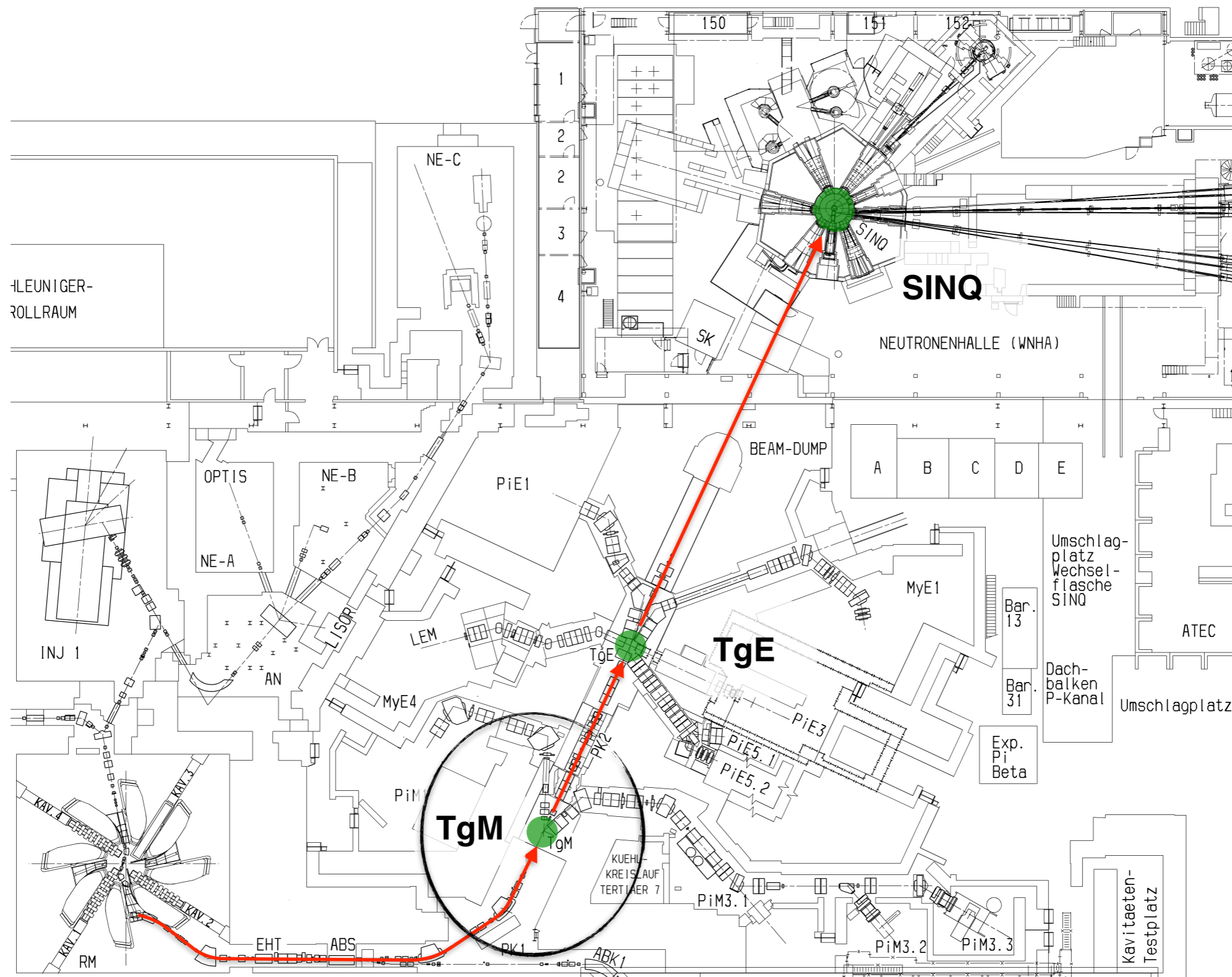

# Target Geometry for new TgM\*

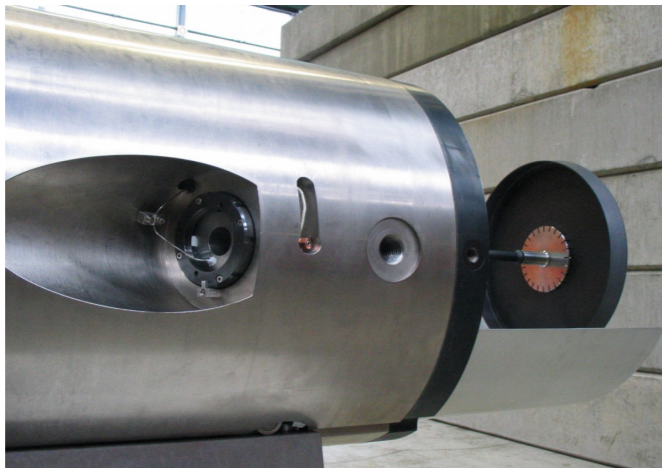

Existing TgM

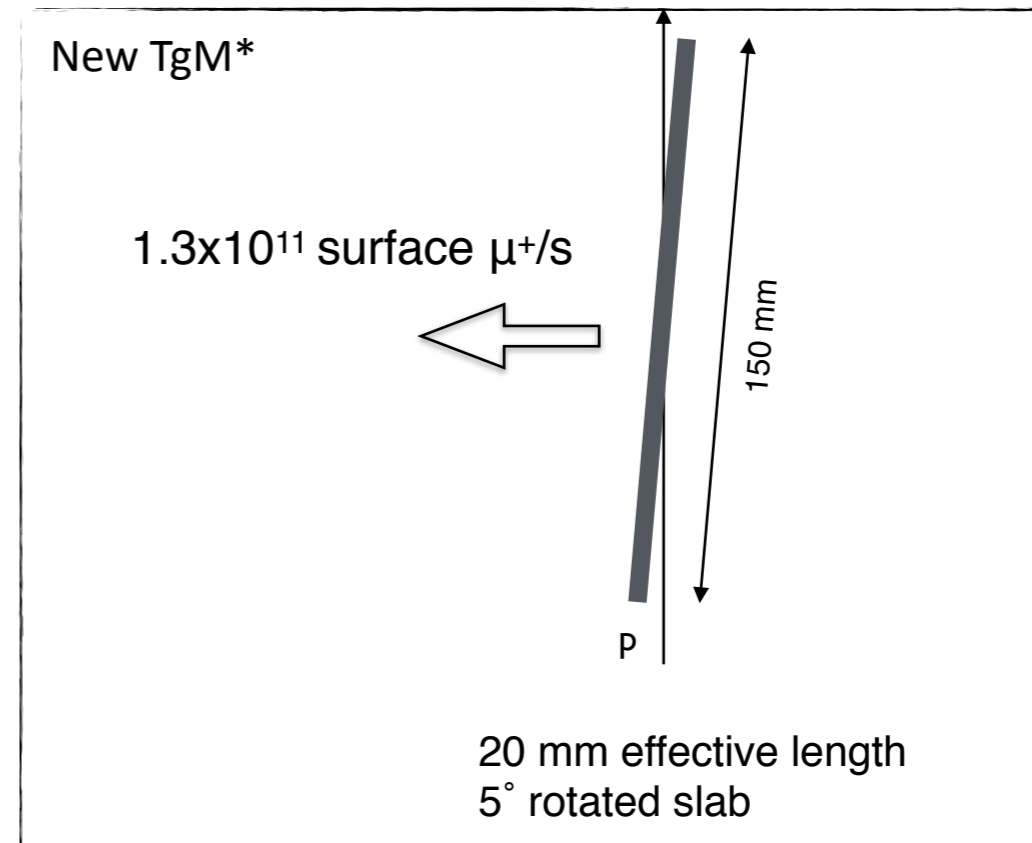

- ▶ Change current 5 mm TgM for 20 mm TgM\* (known situation from 60 mm TgE)
- ▶ 20 mm rotated slab target as efficient as Target E

# Split Capture Solenoids

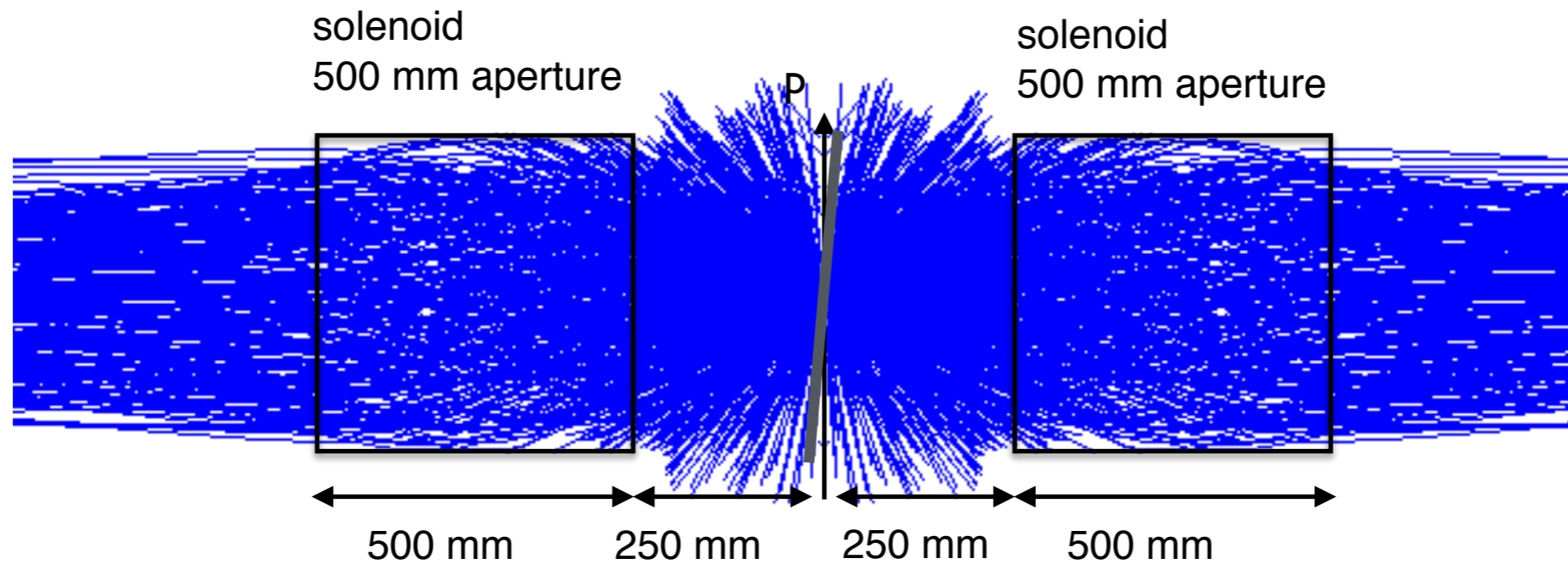

- ▶ Two normal-conducting, radiation-hard solenoids close to target to capture surface muons
- ▶ Central field of solenoids  $\sim 0.35$  T
- ▶ Field at target  $\sim 0.1$  T

# Solenoid Beamline

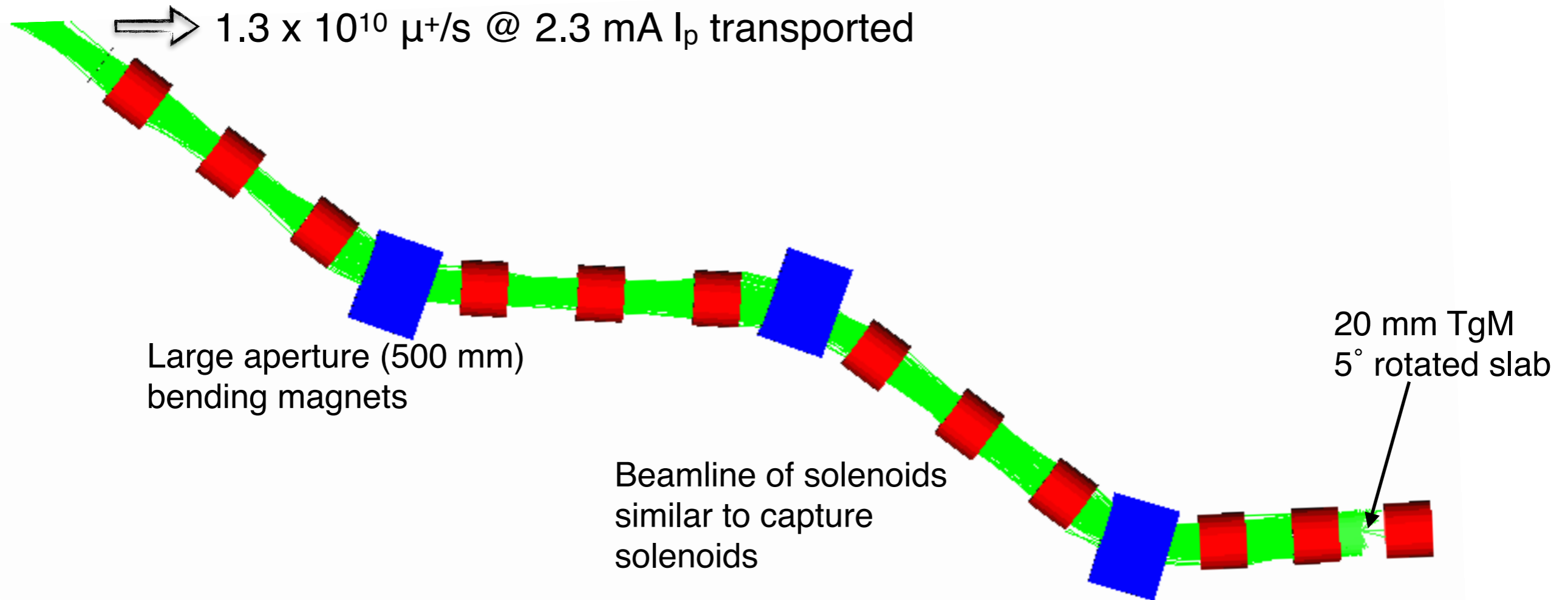

- ▶ First version of beam optics showing that large number of muons can be transported.
- ▶ Almost parallel beam, no focus, no separator, ...
- ▶ Final beam optics under development

# Solenoid Beamline

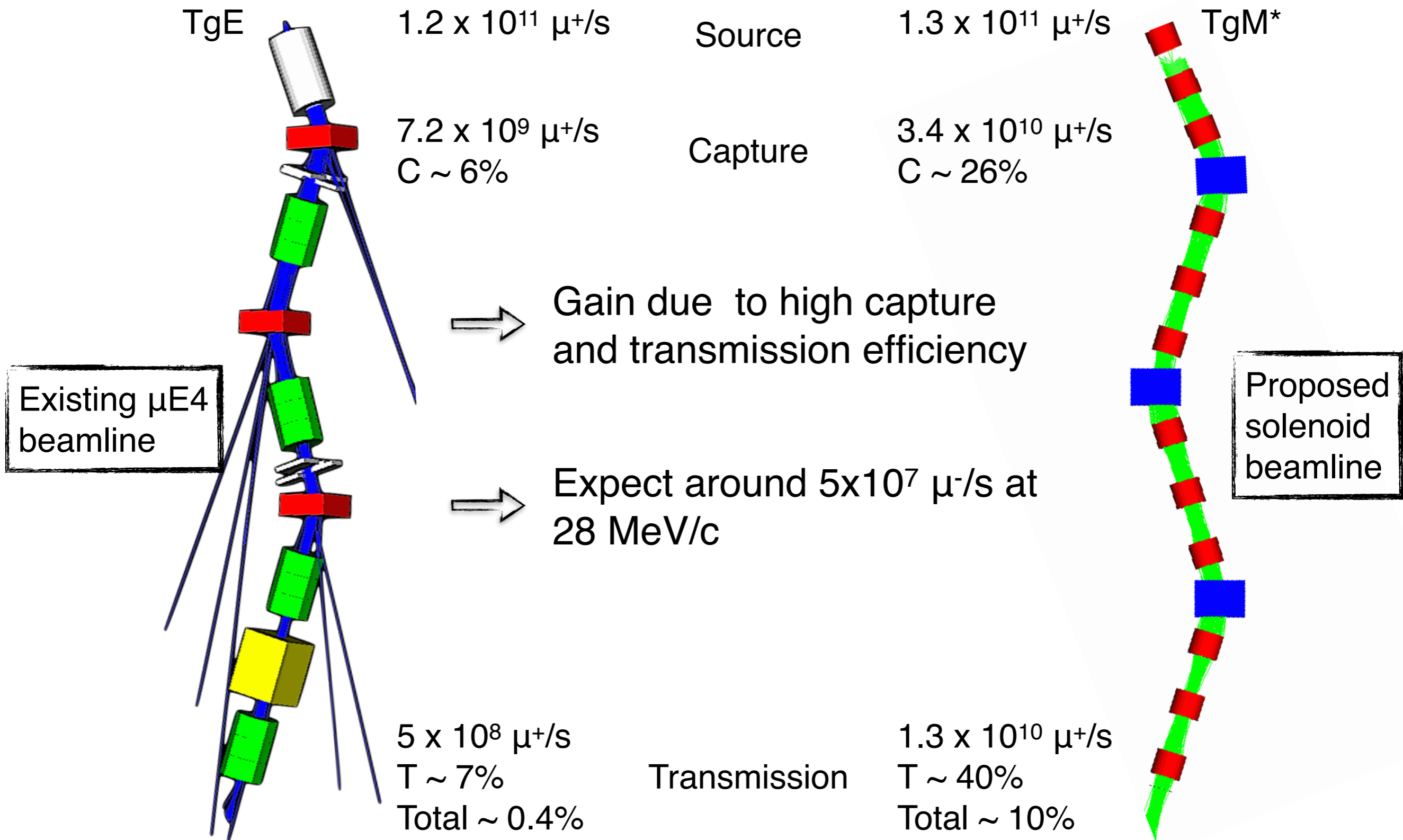

# Building a new target station

- ▶ Challenging environment around TgM to change layout
- ▶ Helium liquefier, tertiary cooling loop 7, lots of pipes, cables and conduits, power supply platforms, ...
- ▶ And of course in an environment with doses measured in Sv/h

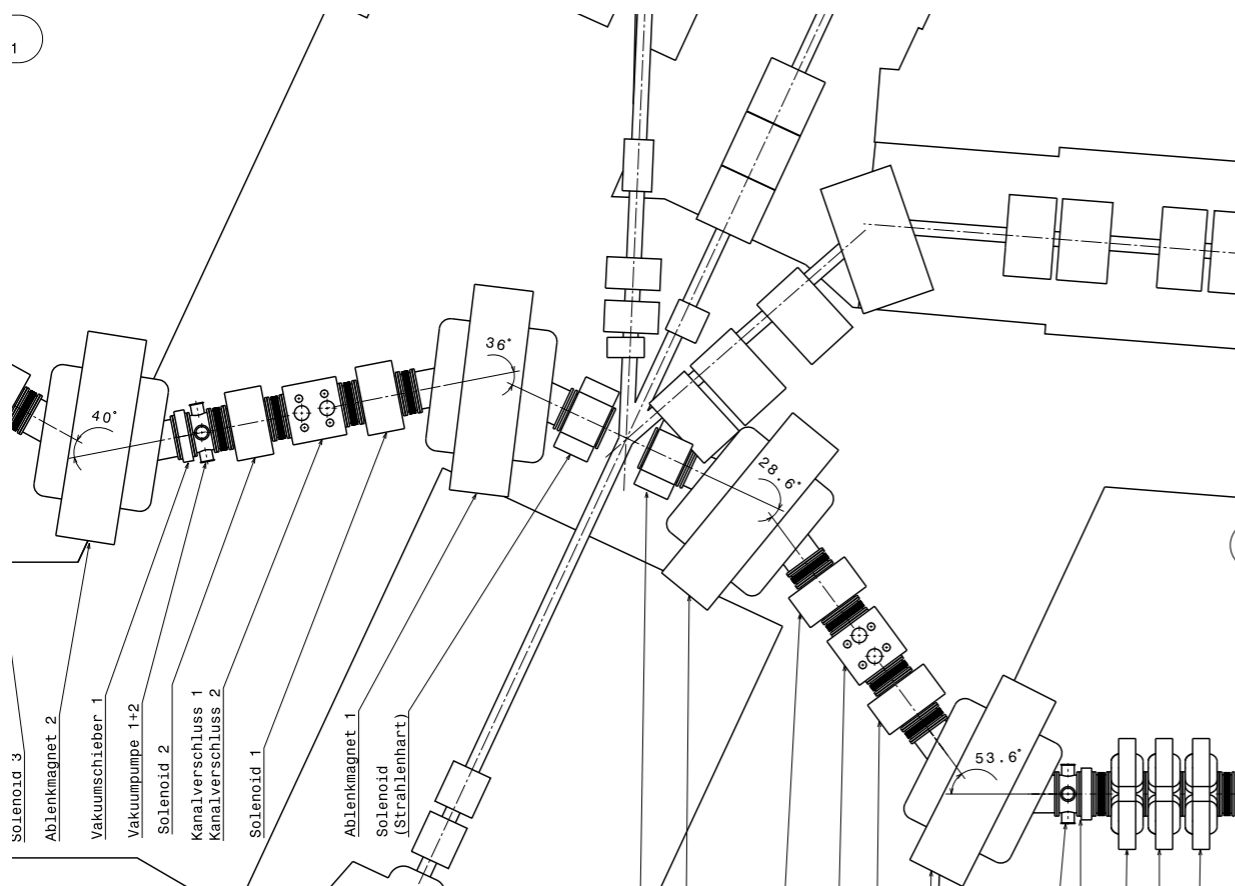



# Challenges!

- ▶ Main topics to study:
  - ▶ Position of new TgM\*
  - ▶ Impact on existing infrastructure
  - ▶ Proton beam optics and channel
  - ▶ Performance of solenoidal channel
  - ▶ Electron/muon separation
  - ▶ New target area & shielding design
  - ▶ Disposal of activated components
  - ▶ Science case
  
- ▶ Timeline:
  - ▶ CDR by end of 2021
  - ▶ Implementation during 2026/2027

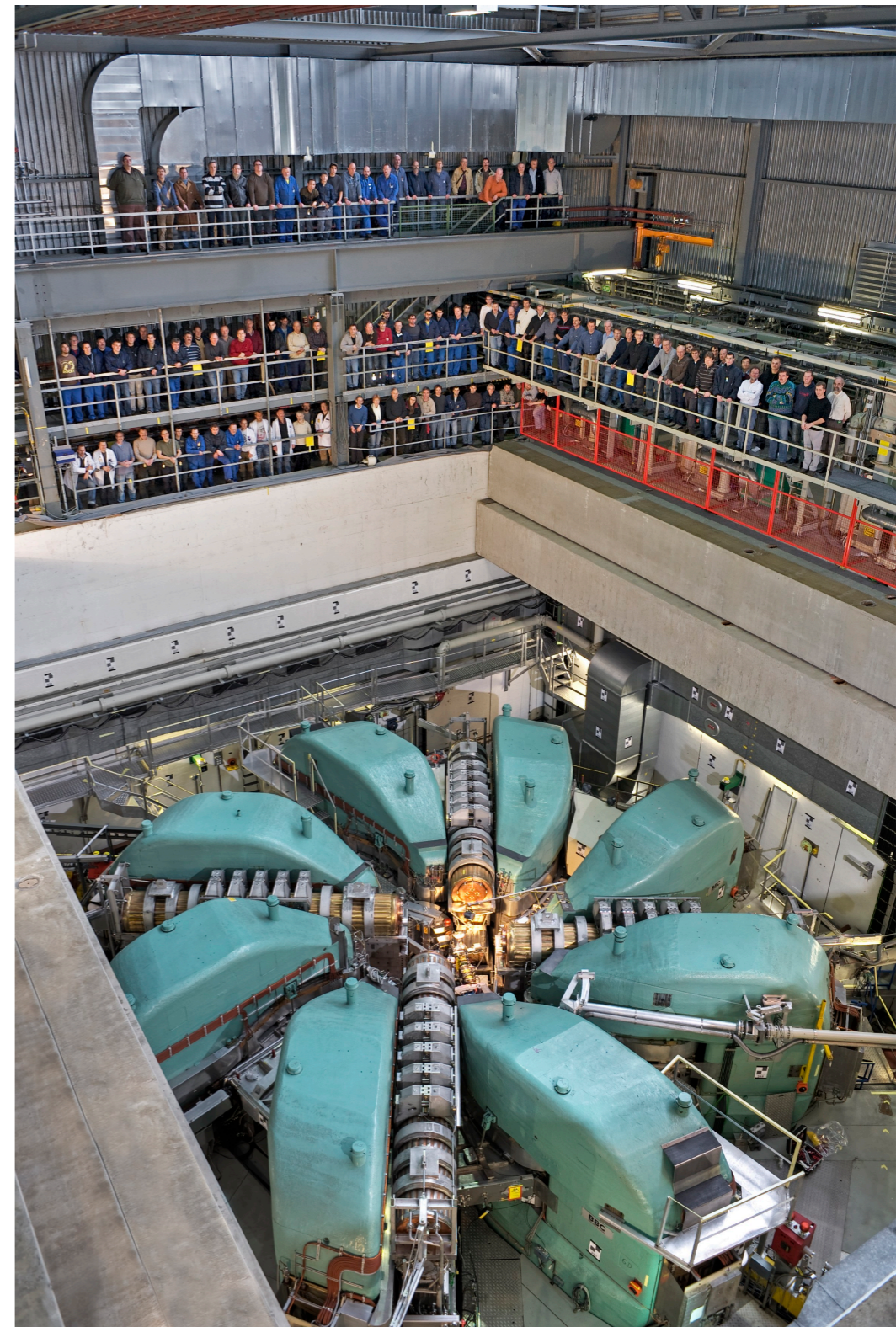

- ▶ PSI beam lines capable of delivering the required pion intensities for future  $\pi \rightarrow e \nu$  and  $\pi \rightarrow \pi^0 e \nu$  experiments
- ▶ PSI would certainly be happy to host such upgraded pion experiments!
- ▶ HIMB project:
  - ▶ Exciting prospects both for  $\mu^+$  and  $\mu^-$  for experiments needing low-energy muons at ultra-high intensities
  - ▶ HIMB will enable forefront muon research at PSI for the next 20+ years



---

Backup

---

- ▶ Measured beam rates for low-energy muons
- ▶ Not stated explicitly, but probably for around 2% momentum bite
- ▶  $\sigma_{x,y} \sim 8$  mm at final focus

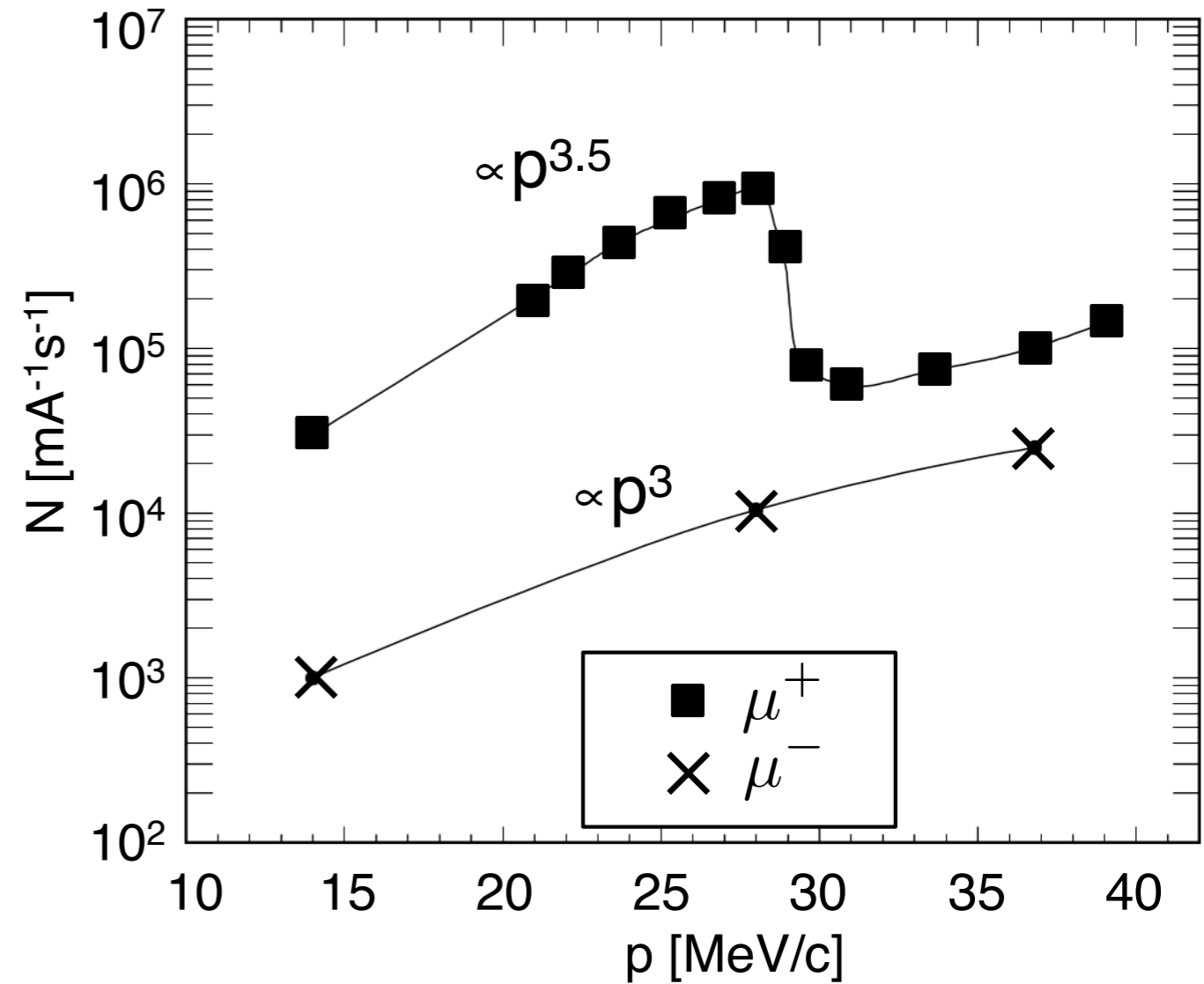

➔  $\sim 20$  kHz @ 28 MeV/c and 2 mA

- ▶ Old measured rates to be taken with a grain of salt  
→ were never reproduced in recent times
- ▶ Expect around  $10^6$   $\mu^-$ /s at 30 MeV/c and 8% momentum bite
- ▶  $\sigma_{x,y} \sim 15$  mm at collimator
- ▶ Scaling as  $p^3$  with momentum and roughly linear in momentum bite

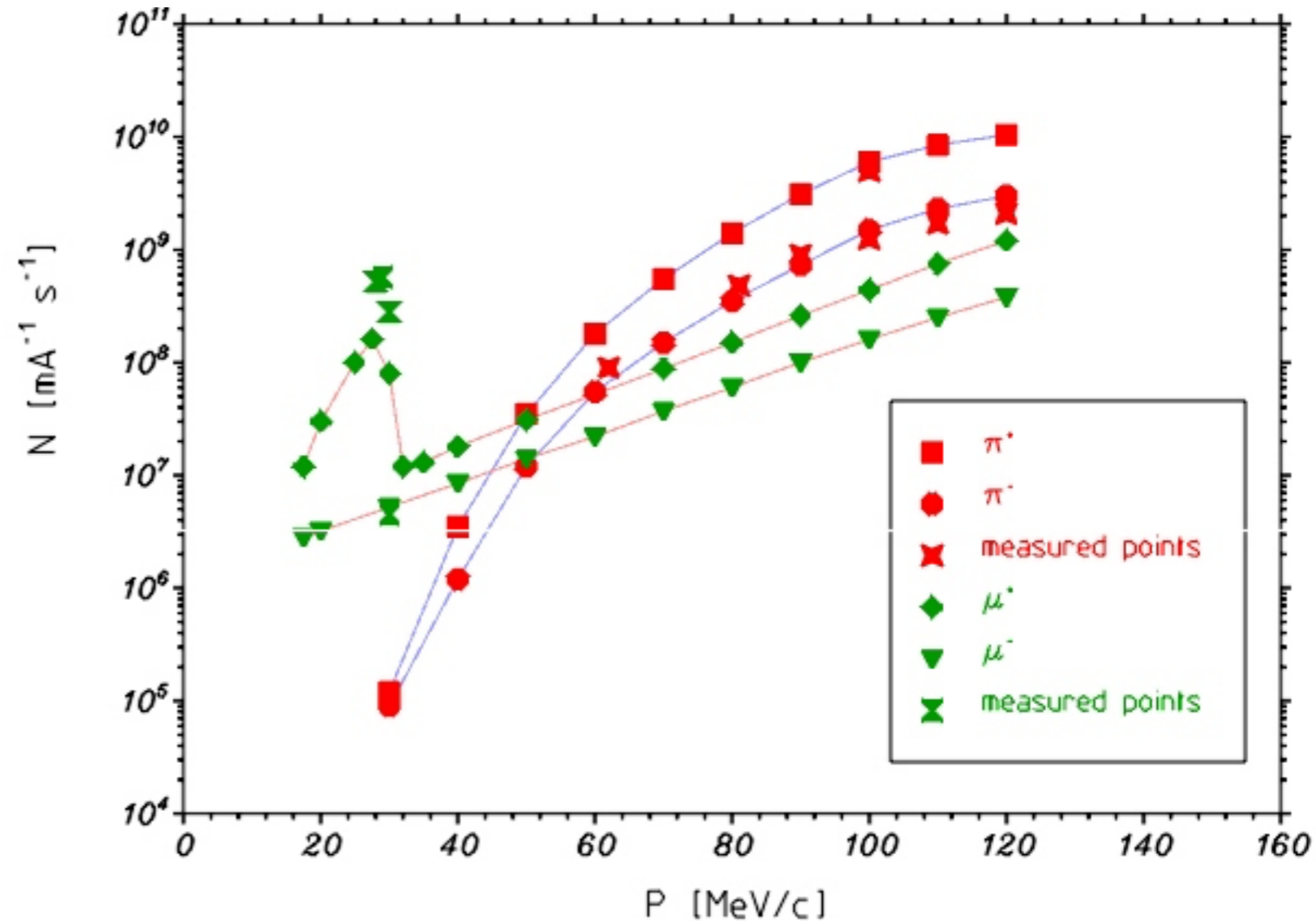

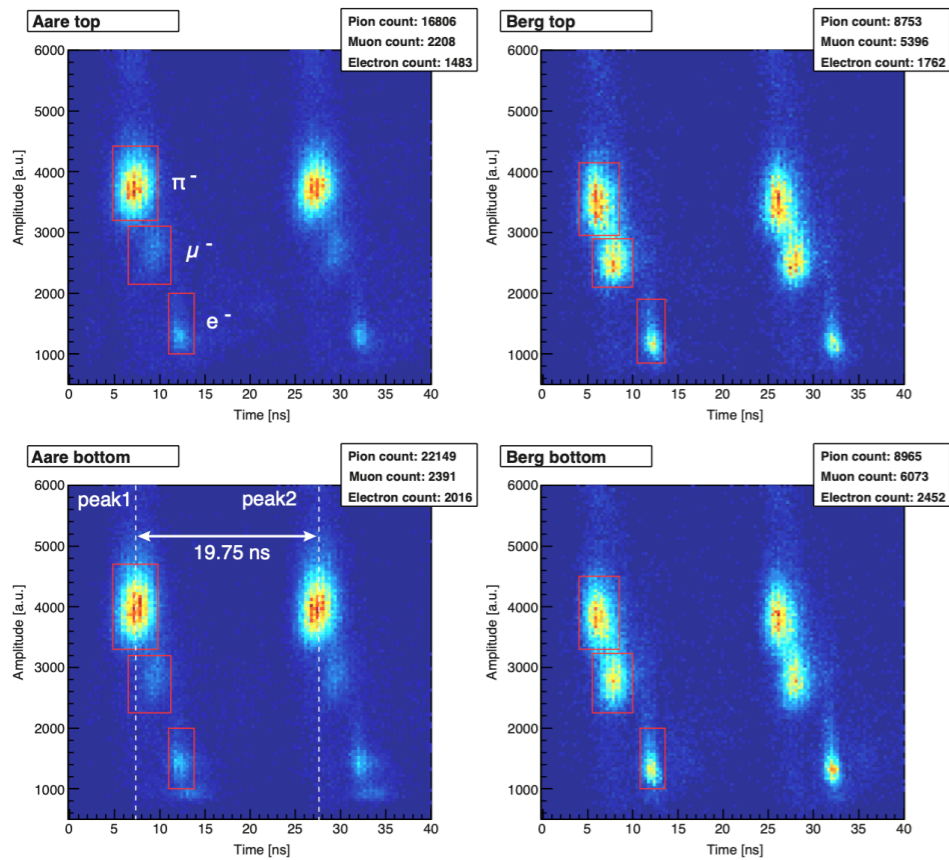

Figure 4.26: Pulse height and time distribution of hits in the four beam counter tiles ( $20 \times 20 \times 4.7 \text{ mm}^3$ ) adding up to a  $40 \times 40 \text{ mm}^2$  (left-right-top-bottom) 4-segment detector. Separation of the electron beam was in the horizontal direction, with the light particles deviating more to the right seen from the point of view of the beam

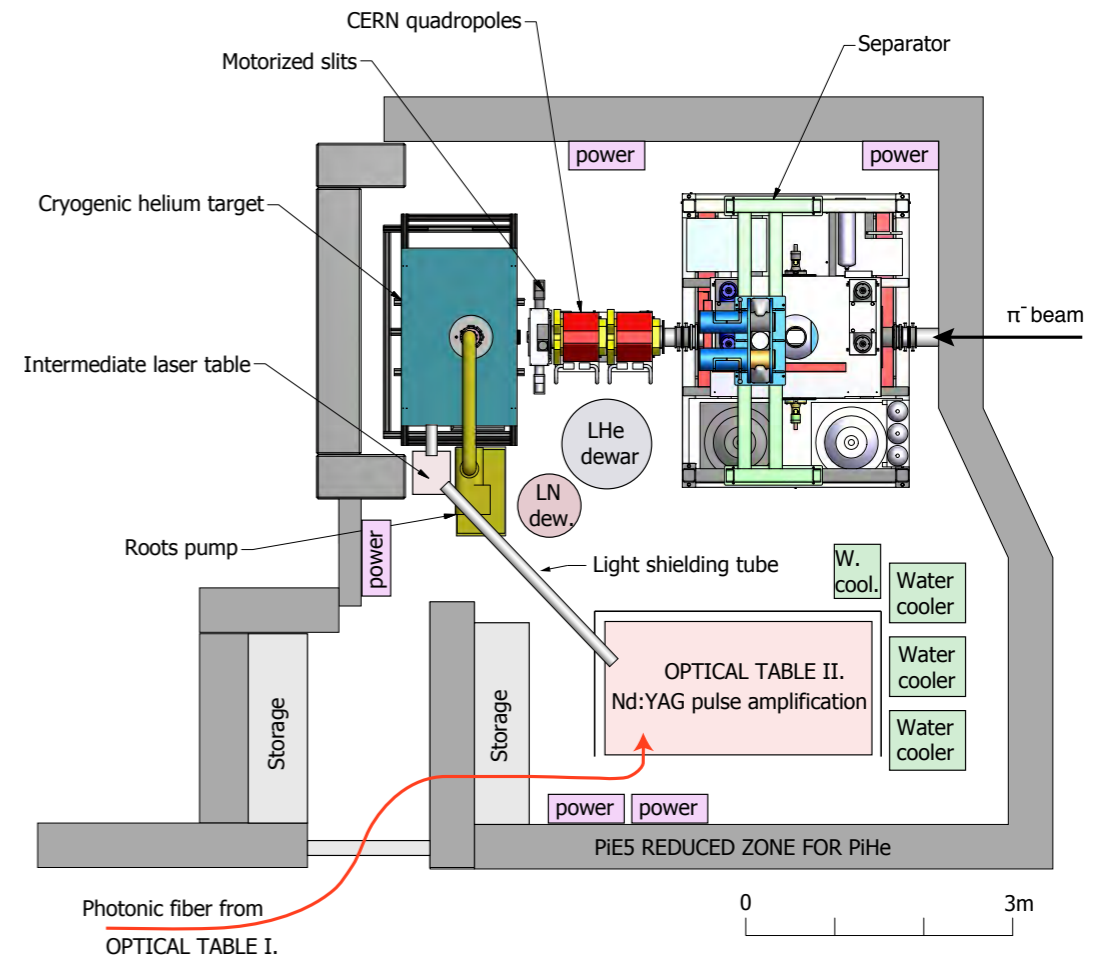
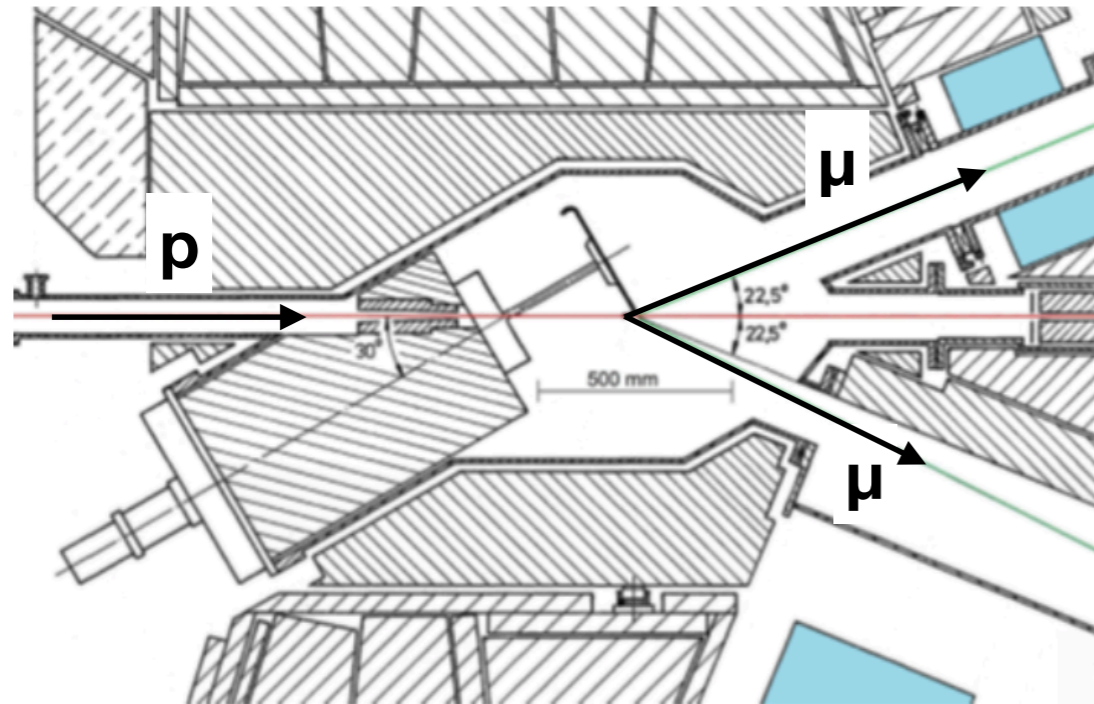
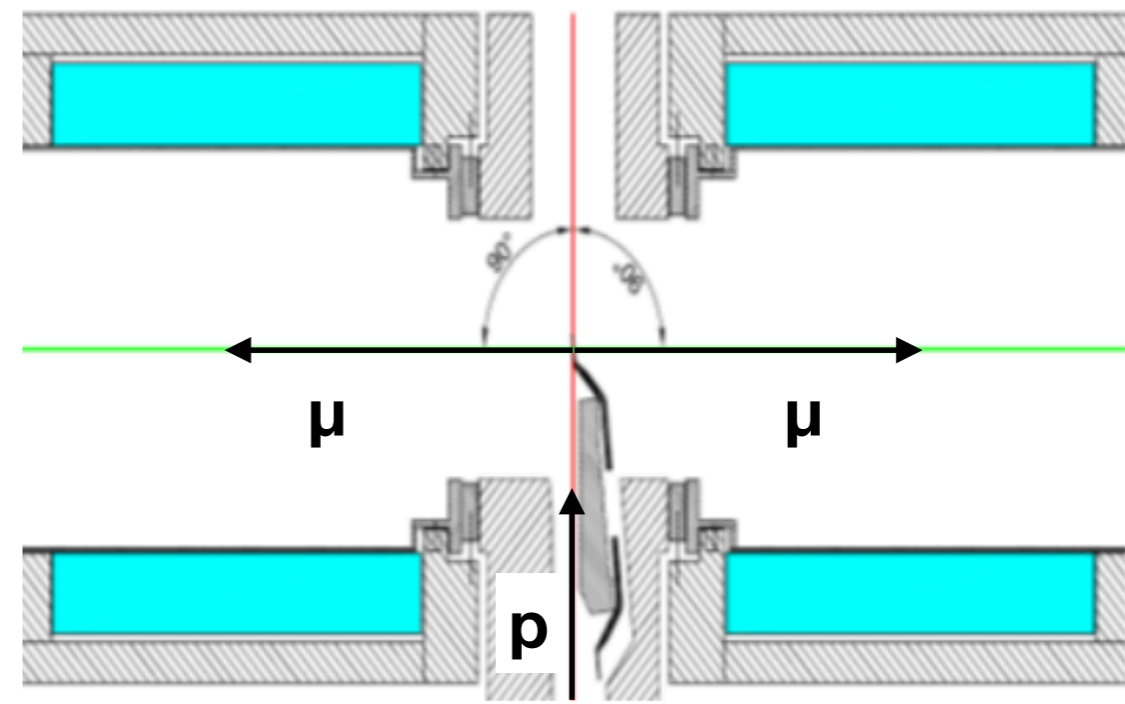

Figure 4.14: To-scale drawing of the  $\pi E5$  zone and the PiHe experiment. The negative pions at  $85 \text{ MeV}/c$  momenta entered the zone at the right side of the image. The spin rotator and the concrete shielding was modified to accommodate our setup, and new power outlets were provided by PSI. A new compact quadrupole doublet from CERN provided the final focus, and a motorized slit afterwards was cutting away the electron beam.

# First ideas for new TgM\* design



Existing TgM



First concept for TgM\*

- ▶ Capture solenoids will need to come very close to the target wheel
- ▶ First concept available showing how this could be accomplished
- ▶ Goal is to use the same exchange flask as TgE for target changes